



MAR.
25 Cents

Radio-Craft

for the
Professional-Serviceman-Radiotrician

HUGO GERNSBACK Editor

IN THIS ISSUE

Articles by

LAURENCE M. COCKADAY

JOHN F. RIDER

D. E. REPLÖGLE

DAVID GRIMES

SYLVAN HARRIS

And Many Others

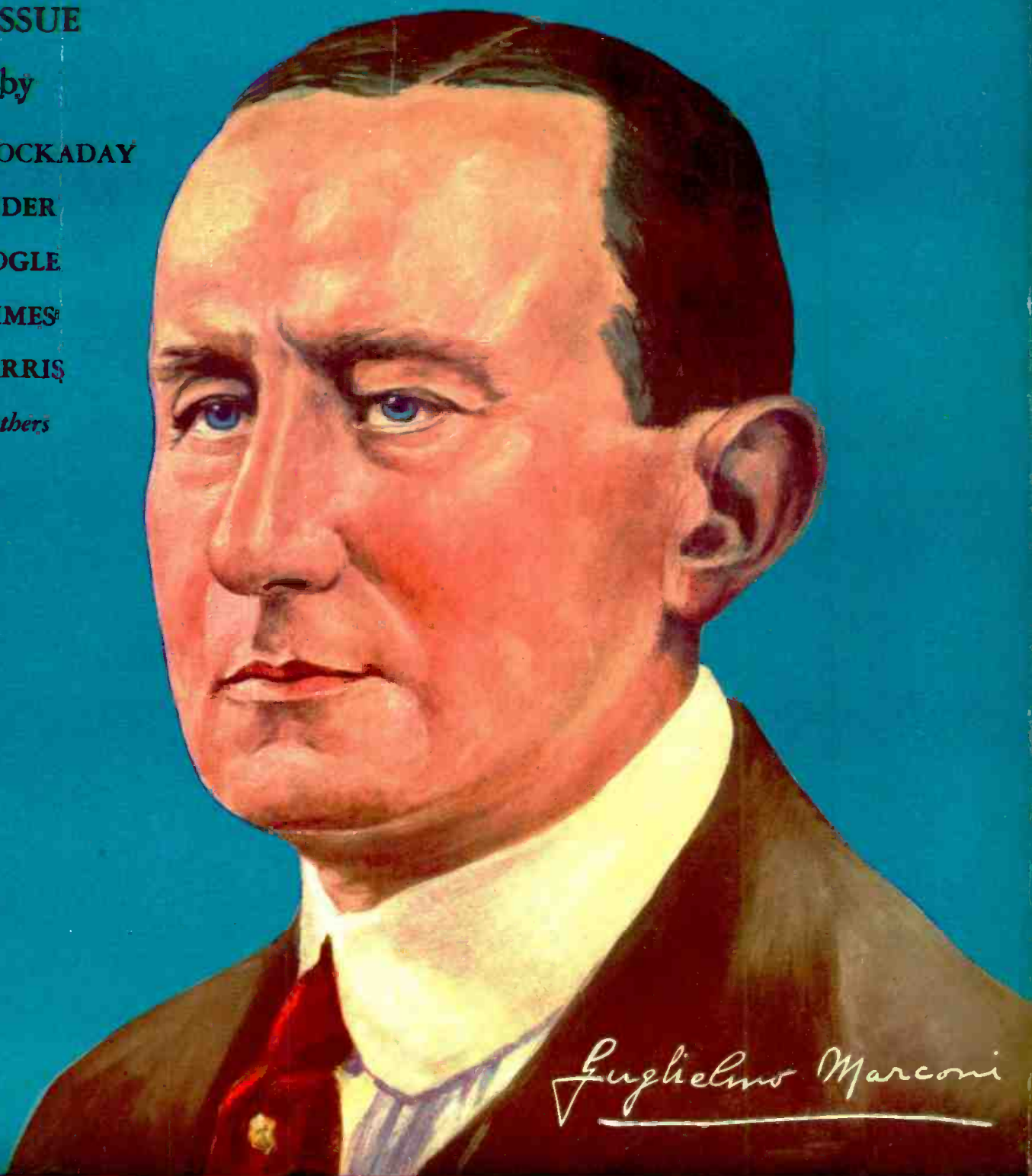

Guglielmo Marconi

Men who have made Radio: Guglielmo Marconi

R. T. I.

R. T. I. QUALIFIES YOU TO MAKE MONEY AND ITS SERVICE KEEPS YOU UP-TO-THE-MINUTE ON THE NEWEST DEVELOPMENTS IN RADIO, TELEVISION, AND TALKING PICTURES

R. T. I.

RADIO
TELEVISION-TALKING PICTURES

TUNE IN ON R.T.I.

BIG MONEY NOW!

More to Come



Radio now offers ambitious men the greatest Money-Making Opportunity the world has ever seen! Hundreds of trained service men are needed by radio dealers, jobbers, and manufacturers!

GOOD JOBS are open for men in all of the many branches of Radio, where qualified men easily earn \$60 to \$100 per week and even \$10,000 a year jobs are plentiful.

BIG MONEY for Spare-Time Radio Work is easily made in every city and village. You can now qualify for this Big-Money work quickly through R. T. I. Get the Big Money Now and go up and up in this Big Pay field. The Radio industry calls for More Men, and R. T. I. supplies what the industry wants you to know.

No Experience Needed

ALL YOU NEED is ambition and the ability to read and write. The Radio industry needs practical trained men. Remember, R. T. I. makes it easy to earn spare time money while you learn at home.

More to come

THE MEN who get into this Big-Money field now will have an unlimited future. Why? Because this billion dollar Radio industry is only a few years old and is growing by leaps and bounds. Get in and grow with it. \$10 to \$25 per week and more is easily made in spare hours while you are preparing for Big Money. TELEVISION, too, will soon be on the market, so the leaders say. Be ready for this amazing new money-making field. Remember, R. T. I. "3 in 1" home-training gives you all the developments in Television and Talking Picture Equipment, together with the complete Radio Training.

Supervised by Radio Leaders

R. T. I. training is prepared and supervised by prominent men in radio, television and talking picture engineering; distributing; sales; manufacturing; broadcasting, etc. These men know what you must know to make money in Radio. You learn easily in spare time at home with the R. T. I. wonderful combination of Testing Outfits, Parts, Work Sheets, Job Tickets.

It is easy, quick and practical, covers everything in Radio —includes Talking Pictures and the latest in Television. Get started in Big Money Radio work now.

Warning

Do not start R. T. I. training if you are going to be satisfied to make \$15 or \$20 per week more than you are now. Most R. T. I. men will make that much increase after a few weeks. There is no reason to stop short of the Big Money Jobs or the Big Profits in a spare time or full time business of your own. No capital needed. Get started with R. T. I. now. Make money while you learn at home.

R. T. I. Book Now

FREE

The thrilling story of Radio, Television and Talking Pictures is told with hundreds of pictures and facts—its hundreds of big money jobs and spare time money-making opportunities everywhere.

Send for your copy now. **USE THE COUPON.**



LET F. H. SCHNELL AND R. T. I. ADVISORY BOARD HELP YOU

Mr. Schnell, Chief of the R. T. I. Staff, is one of the ablest and best known radio men in America. He has twenty years of Radio experience. First to establish two-way amateur communication with Europe.

Former traffic manager of American Radio Relay League, Lieutenant Commander of the U. S. N. R. Inventor and designer of Radio apparatus. Consultant Engineer to large Radio manufacturers.

Assisting him is the R. T. I. Advisory Board composed of men prominent in the Radio industry.



\$60-\$70-\$80-PER WEEK AND UP. That's what R. T. I. training leads to. Send for the R. T. I. Book and see for yourself.



THE R. T. I. ADVISORY BOARD. These men are executives with important concerns in the radio industry—manufacturing, sales, service, broadcasting, engineering, etc., etc. They supervise R. T. I. Work Sheets, Job Tickets, and other training methods.

R. T. I. R. T. I. TRAINS YOU AT HOME FOR A GOOD JOB OR A PROFITABLE PART TIME OR FULL TIME BUSINESS OF YOUR OWN



RADIO & TELEVISION INSTITUTE
Dept. 773 4806 St. Anthony Ct., Chicago

RADIO & TELEVISION INSTITUTE
Dept. 773, 4806 St. Anthony Court, Chicago

Send me Free and prepaid your BIG BOOK "Tune In On Big Pay" and full details of your three-in-one Home Training (without obligating me in any way).

Name.....

Address.....

City..... State.....

4 of the 40 Easy Ways to Make \$3⁰⁰ an Hour

In Your Spare Time in RADIO

Below are a few of the reports from those now cashing in on the "40 Easy Ways"

THE four plans shown are but a sample of the many ways in which our members are making \$3.00 an hour upwards, spare time and full time, from the day they join the Association. If you want to get into Radio, have a business of your own, make \$50 to \$75 weekly in your spare time, investigate the opportunities offered the inexperienced, ambitious man by the Association.

Our Members Earning Thousands of Dollars Every Week

The Association assists men to cash in on Radio. It makes past experience unnecessary. As a member of the Association you are trained in a quick, easy, practical way to install, service, repair, build and rebuild sets—given sure-fire money-making plans developed by us—helped to secure a position by our Employment Department. You earn while you learn, while you prepare yourself for a big-pay Radio position.

The Association will enable you to buy parts at wholesale, start in business without capital, help you get your share of the \$600,000,000 spent annually for Radio. As a result of the Association, men all over the country are opening stores, increasing their pay, passing licensed operator examinations, landing big-pay positions with Radio makers.



Mail Coupon Today for the FREE HANDBOOK

It is not only chock-full of absorbing information about Radio, but it shows you how easily you can increase your income in your spare time. Mailing the coupon can mean \$50 to \$75 a week more for you.

Radio Training Association of America
4513 Ravenswood Avenue Dept. RCA-3 Chicago, Illinois

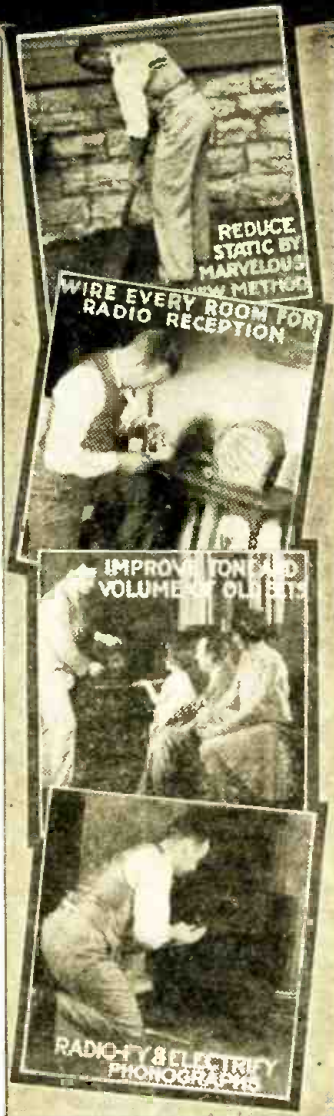

Clears \$3,000.00 Frank J. Deutch, Pa.—“Since joining the Association I have cleared nearly \$3,000.00. It is almost impossible for a young fellow to fail, no matter how little education he has, if he will follow your easy ways of making money.”

\$1,100.00 in 6 Weeks J. R. Allen, Calif. — “Have done over \$1,100.00 worth of business in the last 6 weeks. Next month I am going to open up a store of my own. I never knew that money could come so fast and easy.”

\$25.00 a Week Spare Time N. J. Friedrich, N. Y.—“I have averaged \$25.00 a week for the last 7 months even though I am not a graduate but just learning.”

Training Lands Him Job R. C. Kirk, N. C.—“Your training has been very valuable to me. I landed a job with the big department store out here a few weeks ago because I had my membership card with me. There were a large bunch of applications ahead of me.”

ACT NOW If You Wish NO-COST Membership

For a limited time we will give to the ambitious man a No-Cost Membership which need not—should not—cost you a cent. For the sake of making more money now, and having a better position in the future, mail coupon below *now*. You'll always be glad you did.

Radio Training Association of America
Dept. RCA-3 4513 Ravenswood Ave., Chicago, Ill.

Gentlemen: Please send me by return mail full details of your Special No-Cost Membership Plan, and also a copy of your Radio Handbook.

Name

Address

City State

H. GERNSBACK, President
 S. GERNSBACK, Treasurer
 J. M. HERZBERG, Vice-President
 I. S. MANHEIMER, Secretary

R. D. WASHBURNE,
 Technical Editor



HUGO GERNSBACK, Editor-in-Chief

JOHN F. RIDER,
 Editor Service Dept.

C. P. MASON,
 Associate Editor

VOLUME I
 NUMBER 9

Contents of This Issue

MARCH
 1930

	Page		Page
SHORT-WAVE OPPORTUNITIES		LOCATING HUM IN "A" ELIMINATORS	
By Hugo Gernsback	425	By John F. Rider	412
SERVICE MEN'S DEPARTMENT:		NEW RADIO DEVICES	443
TAKE NOTHING FOR GRANTED!	426	SHORT-WAVE DEPARTMENT:	
By John F. Rider		NEW DEVELOPMENTS IN SHORT-WAVE	
LEAVES FROM SERVICE MEN'S NOTEBOOKS		RADIO	444
By Radio-Craft Readers	427	SHORT-WAVE TRANSMITTER DESIGN AND	
OPERATING NOTES FOR SERVICE MEN		OPERATION	416
By Bertram M. Freed	429	PORTABLE PHONE SYSTEM FOR ADJUSTING	
SERVICING THE FRESHMAN "QD-16S"		TRANSMITTING ANTENNAS.....	449
By Harold Weiler	430	RECEPTION WITH A RADIOVISOR	
THE CONSTRUCTION OF A RADIO WORK		(Part II)	450
BENCH	431	THE INVENTOR AND HIS PATENT	
CAUSES AND CURE OF RADIO INTERFERENCE		By J. Harold Byers	451
(Part III)	433	AMPLIFYING THE TELEVISION SIGNAL	
RADIO SERVICE DATA SHEETS	434	By C. H. W. Nason	452
THE SERVICE MAN'S OPEN FORUM.....	436	SHORT-WAVE STATIONS OF THE WORLD.....	453
MEN WHO MADE RADIO—GUGLIELMO MARCONI	437	MODERN SOUND PROJECTION (Part II)	
"NATIONAL LIST OF SERVICE MEN" ENROLL-		By Richard Carman	454
MENT BLANK	437	THE COOPERATIVE LABORATORY	
TROUBLES IN RADIO MASS PRODUCTION		By David Grimes	458
By Sylvan Harris	438	\$100 IN GOLD FOR A SLOGAN	459
OBTAINING ENERGY FOR A DYNAMIC		"RADIO-CRAFT" KINKS	460
REPRODUCER	439	THE RADIO CRAFTSMAN'S OWN PAGE.....	461
SERVICING AUTOMOBILE RADIO		INFORMATION BUREAU	462
INSTALLATIONS (Part II)	440	LONG-WAVE WEATHER BROADCASTS	468
WHY NEW SETS USE "KILOCYCLE" DIALS		"RADIO-CRAFT" SLOGAN COUPON	470
By H. B. Richmond	442	BOOK REVIEWS	478
		"RADIO-CRAFT" OPPORTUNITIES COLUMN.....	479

In Forthcoming Issues

A NEW DEVELOPMENT IN SHORT-WAVE TUNING.
 Details of a new invention which enlarges the tuning range of a single inductance to cover the whole band of short waves from 20 meters up to 200, without the annoyance of changing coils.

THE BROAD FREQUENCY-ACCEPTOR. By Henri Francois Dalpayrat. An interesting development in a band-pass filter arrangement for a broadcast receiver, which greatly increases selectivity without impairing sensitivity. Details of its construction are given.

THE PILOT "PE-6" SCREEN-GRID RECEIVER. By Robert Hertzberg. A new set for the custom-set builder,

and the fan who rolls his own, giving compactness and power in A.C. operation.

RECTIFIER-TUBE DESIGN AND USE. By C. W. Palmer. Contains much valuable information and many helpful suggestions on servicing and testing this indispensable adjunct to electric receiver operation.

FORMULAS EVERY SERVICE MAN SHOULD KNOW. By Boris S. Naimark. Accompanied by convenient charts of fundamental formulas that are useful for reference when you want them.

AND MANY OTHER PRACTICAL SERVICING AND CONSTRUCTIONAL ARTICLES.

RADIO-CRAFT is published monthly, on the fifth of the month preceding that of date; its subscription price is \$2.50 per year. (In Canada and foreign countries, \$3.00 a year to cover additional postage.) Entered at the postoffice at Mt. Morris, Ill., as second-class matter under the act of March 3, 1879. Title registered U. S. Patent Office. Trademarks and copyrights by permission of Gernsback Publications, Inc., 98 Park Place, New York City.

Text and illustrations of this magazine are copyright and must not be reproduced without permission of the copyright owners. We are also agents for SCIENCE WONDER STORIES, AIR WONDER STORIES, SCIENTIFIC DEFECTIVE MONTHLY and SCIENCE WONDER QUARTERLY. Subscriptions to these magazines may be taken in combination with RADIO-CRAFT at reduced Club rates. Write for information.

Copyright 1930, GERNSBACK PUBLICATIONS, INC.

Published by
TECHNI-CRAFT PUBLISHING CORPORATION

Publication Office: 404 No. Wesley Ave., Mount Morris, Illinois

Editorial and Advertising Offices
 96-98 Park Place, New York City

Western Advertising Office
 737 North Michigan Avenue, Chicago, Ill.

L. F. McCLURE, Western Advertising Representative

London Agent: Hachette & Cie.,
 16-17 King William St., Charing Cross, W.C. 2

Paris Agent: Hachette & Cie.,
 111 Rue Reaumur

Australian Agent: McGill's Agency,
 179 Elizabeth St., Melbourne

Now YOU CAN LEARN ELECTRICITY

In the Great Coyne Shops Without Books or Lessons

in 12 WEEKS!



LEARN BY DOING- NOT BOOKS OR LESSONS

My Amazingly Easy Way Will Astonish You

Don't spend your life waiting for five dollar raises in a dull, hopeless job. Now—and forever—say good-bye to twenty-five and thirty-five dollars a week. Let me show you how to qualify for jobs leading to salaries of \$60, \$70, \$100 and up, a week, in Electricity—NOT by books or correspondence, but by an amazing way to teach that makes you an Electrical Expert in 90 days. Getting into Electricity is far easier than you imagine!

NO BOOKS -- NO LESSONS NO CLASSES

No dry, uninteresting books to study. No lessons to learn. No classes to attend. All actual electrical work—right here in the great Coyne Shops—building real batteries—winding real armatures—operating huge motors and generators, wiring houses, repairing radio sets, working on auto and airplane engines, etc., etc. In one department alone we generate enough electricity to supply a small city with power!

No Advanced Education or Previous Experience Needed

You need no advanced education, because I don't teach you out of books. And because you learn by actually doing the work yourself, you get all the experience you'll need right here at Coyne. I don't care if you don't know an armature from a generator; if you're 16 years old or forty-five. It makes no difference! I will prepare YOU for a Big Pay Electrical Job in 90 days' time.



Prepare for Jobs Like These

Here are a few of hundreds of positions open to Coyne-trained men. Our free employment bureau gives you lifetime employment service.
Armature Expert, to \$100 a Wk.
Substation Operator \$60 a Week and up
Auto Electrician \$110 a Week
Inventor Unlimited
Maintenance Engineer up to \$150 a Week
Service Station Owner up to \$200 a Week
Radio Expert up to \$100 a Week

Get My Big Free Book

Mail the coupon and let me send you the big Coyne book of 150 photographs—facts—jobs—salaries—opportunities. This costs you nothing and does not obligate you in any way. Just mail the coupon

JOBS—PAY—FUTURE

Sixty-thousand new Electrical Experts are needed every year. Thousands needed NOW for jobs paying \$60, \$70, \$100 and up a week. So don't worry about a job—Coyne Training settles the job question for life. Just recently one concern called on me for 150 graduates. And calls for more men are coming in almost daily. My big, expert Employment Department will help you and back you up as long as you live, without one cent of cost to you.

EARN As You LEARN

And don't let lack of money stop you. Most of the men at Coyne have no more money than you have. Many of them pay practically all their expenses through spare time work we get for them. I will allow you your railroad fare to Chicago, and help you land a good part-time job the day you arrive, if you want it. Then when you graduate I'll give you lifetime employment help anytime you want it.

Special Aviation Offer

Right now I am giving an extra special training in radio, Auto Ignition and Aviation Electricity, without one cent of extra cost. Also, I'm making a most unusual tuition offer. But to get these big advantages, you must act at once! So tear out the coupon and MAIL IT TODAY! Find out how quickly and easily you can land a Big Pay Electrical Job. Just mail the coupon.

COYNE ELECTRICAL SCHOOL
H. C. Lewis, Pres. Est. 1899
500 S. Paulina St. Dept. 30-95 Chicago, Ill.

H. C. LEWIS, President
COYNE ELECTRICAL SCHOOL, Dept. 30-95
500 S. Paulina St., Chicago, Ill.

Gentlemen: Please send me free your big 12 x 15 Book, with 150 illustrations and your special offer of Two Free Courses.

Name.....
Address.....
City..... State.....

"The World's Champion"

Find-All Screen Grid FOUR

**12,000 MILES OF VERIFIED RECEPTION OF A 100-WATT STATION!
STATION 2UW, SYDNEY, AUSTRALIA**

This wonderful WORLD'S RECORD was not made on "short waves" but on the regular broadcast band on a wave length of 267 meters by John White, 3054 Kingsbridge Ave., New York City. It was not made with a ten-tube super-heterodyne but with the marvelous FIND-ALL FOUR—*Correctly Designed* to utilize all the latent possibilities of the screen grid tube.

**HERE IS A CUSTOM-BUILT RADIO THAT FOR
DISTANCE AND QUALITY HAS NO EQUAL**

It is the supreme achievement of a man who has the respect of the entire radio industry. The "FIND-ALL FOUR" was designed principally for radio fans who desire reception from stations all over this country and foreign stations as well. While it is battery operated it can also readily be adapted as an A.C. or D.C. ELECTRIC SET. Although compact it is one of the most powerful receivers on the market today. Its reception surpasses that of many six or eight tube sets. It can be used with the ordinary magnetic speaker or with the most modern dynamic reproducer. The WORLD'S CHAMPION "FIND-ALL FOUR" is made up in a handsome Table Model cabinet and also in complete kit form with blueprint and complete instructions for assembly.

TABLE MODEL, Complete—Less Tubes \$35.00
COMPLETE KIT—Blueprint and Instructions . . . \$25.00

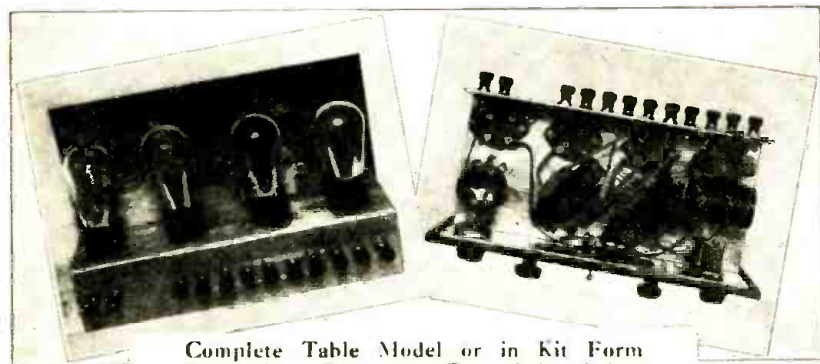
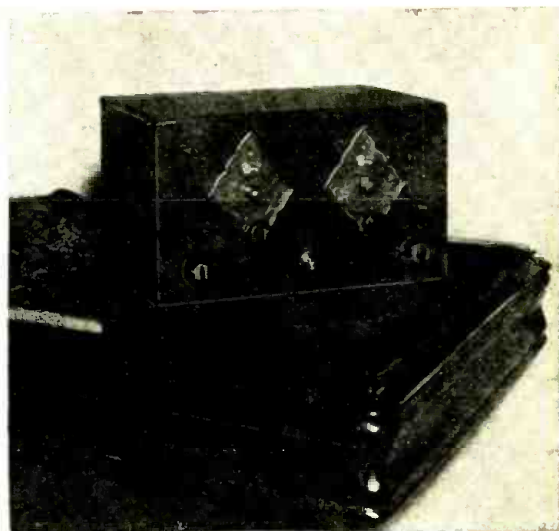

Complete Table Model or in Kit Form
Direct from Factory at Remarkable Prices

POINTS OF SUPERIORITY

- (1) DISTANCE—Marvelous distance reception due to correct use of the modern Screen Grid Tube has been verified with this set. Stations in New Zealand, Japan, Canada and other foreign countries have been clearly received.
- (2) TONE QUALITY—Clear, natural undistorted quality—found only in the most expensive sets.
- (3) VOLUME—Plenty of volume even on distant stations.
- (4) TWO DIAL Control gives sharper tuning for greater distance.
- (5) EQUIPMENT—Only extra equipment—Batteries or Eliminators, one 222 Tube, two 201A Tubes, one 171A Power Tube and Speaker.
- (6) COMPACT CONSTRUCTION — Cabinet measures exactly 7 x 7 x 12 inches. Aluminum chassis of latest design.
- (7) KIT—Can be assembled and wired by merest novice in less than an hour. Chassis furnished completely drilled.

BANK REFERENCES:
Fidelity Trust Co., New York

SEND US YOUR ORDER NOW—Mention this Series—RC-3

FIND-ALL RADIO CO.

Designers and Manufacturers of Custom Built Radios

Suite 707, 285 Madison Ave.

Find-All
Screen Grid
FOUR

New York City

Thousands of Positions Open Right Now

at

Salaries Ranging

UP to \$200⁰⁰ per WEEK

for MOTION PICTURE SOUND Engineers

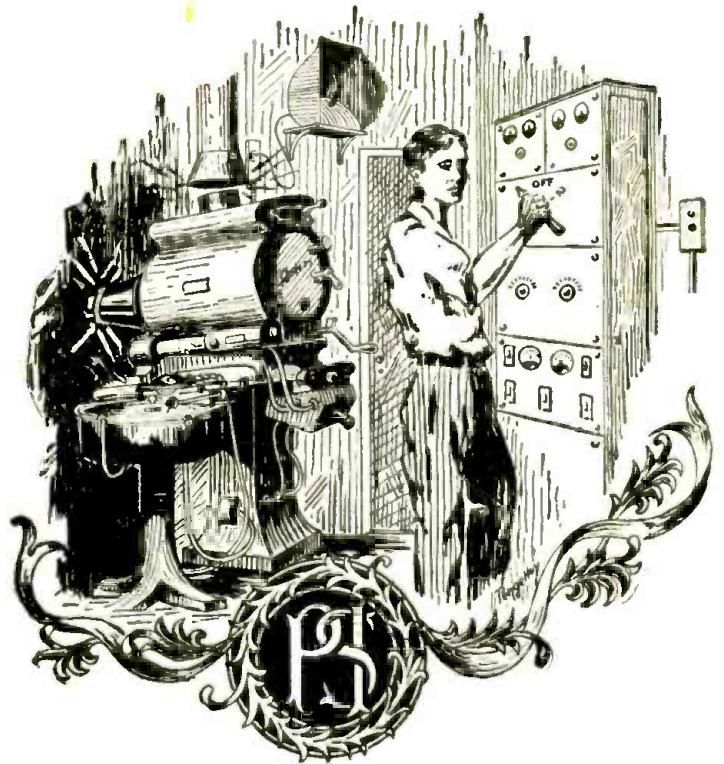

WE are in contact with chain theatres and manufacturers of Sound equipment who desire the services of competent sound men as engineers, projectionists, installation and service men. Our employment department will assist you in making a profitable connection free of charge.

GUARANTEE

Our guarantee insures you that if you enroll as one of our students and take advantage of the many opportunities that your membership entitles you to your increased income will pay the tuition of the course many times. We unconditionally guarantee that if for any reason you are dissatisfied (you being the judge) we will refund every cent you have paid.

Due to the fact that radio and sound are so closely allied, men with radio experience are the most adaptable.

POLICY

Our course on Sound Projection which is prepared by the most eminent authorities on Electrical Acoustics will qualify you for a Profession whose place in the engineering world is second to none. All of the available knowledge of the art and the underlying fundamental principles of sound is given to you in an everyday, plain-talk language, as well as two weeks' practical training in the operation, servicing and installation of Sound Equipment.

DEMAND

In the 20,000 theatres throughout the United States and Canada,

which now employ approximately 50,000 projectionists, it is estimated that a very small per cent of this number are qualified to fill the position as Sound operators. Many thousands of new men will have to be taken into this field as fast as the many thousand unwired theatres are wired for sound as the additions of sound doubles the number of operators required. This condition will create many thousands of positions at salaries up to \$200.00 per week.

The tuition for these courses is very reasonable and is payable in easy installments as you study. Also you have the added convenience of studying at home in your spare time. Fill out and mail the coupon below today for special scholarship proposition.

Mail Coupon for Free Information

**PROJECTIONIST
SOUND
INSTITUTE**
"The Authority"
EASTON, PENNA.

PROJECTIONIST SOUND INSTITUTE,
EASTON, PENNA. RC-3

Gentlemen:
Please send me, by return mail, full details of your Special Scholarship Proposition on Sound Projection.

Name.....

Address.....

City..... State.....

The **BIG 3** always in the SPOTLIGHT of Scientific Fiction

A SCIENTIFIC EDUCATION WHILE READING THE MOST MARVELOUS FICTION

Once you have read your first science fiction magazine, you will never let a month pass without making every effort to read the next issue. Hours of pleasant pastime are well spent in reading stories that you like—stories written by men who have spent many years in study of the science and have attained literary success—stories that are entertaining and educational as well. In the Science Fiction Group you will read stories of the H. G. Wells, Jules Verne and Arthur B. Reeve type, with a techni-scientific background.



SCIENCE WONDER STORIES exploits the present and the future by giving you the most marvelous stories that have ever been put into print. Interplanetary trips, space-flyers, talking to Mars, death rays, gravity-nullifiers, transmutation of elements, trips to other worlds, are some of the subjects treated in SCIENCE WONDER STORIES.

This magazine publishes only scientific fiction of the type that made Jules Verne, H. G. Wells, and Edgar Rice Burroughs famous.



NOW—for the first time, advanced thought on scientific crime detection is published in a profusely illustrated monthly magazine. SCIENTIFIC DETECTIVE MONTHLY is truly the most amazing publication ever issued and the most fascinating reading ever set into type. 100 pages—every one chock full of gripping revelations and stirring situations. All based on newly discovered scientific facts.



What will aviation be like fifty years hence, one hundred years hence, five thousand years hence?

The answer to this question is found in the most unique aviation fiction magazine in print.

AIR WONDER STORIES presents solely flying stories of the future, strictly along scientific-mechanic technical lines, interspersed with exploration and achievement. All of these stories are of the scientific fiction type.

THEY ARE ALL DRAMATIZED MECHANICS OF THE AIR.

In addition to this, AIR WONDER STORIES now publishes interplanetary stories by which you visit strange worlds and strange races and find strange adventures.

25c The Copy *On All Newsstands* or use coupon for Big Saving

MAIL
COUPON
→
NOW

STELLAR PUBLISHING CORP.,
98 Park Place,
New York, N. Y.

Enclosed find \$....., for which enter my subscription to

SCIENTIFIC DETECTIVE MONTHLY
 SCIENCE WONDER STORIES
 AIR WONDER STORIES

for eight months. Check which you prefer.
(Canada and foreign \$1.25.)

Name

Address

City..... State.....

R.C. 330

8 MONTHS
ANY ONE MAGAZINE
\$1.00
(Canada and foreign \$1.25)

It's all they say it is - and more!



\$2.00

Made of ebony black hard rubber. Nickel clip and self-filling lever. 14 Kt. white gold point and feed.

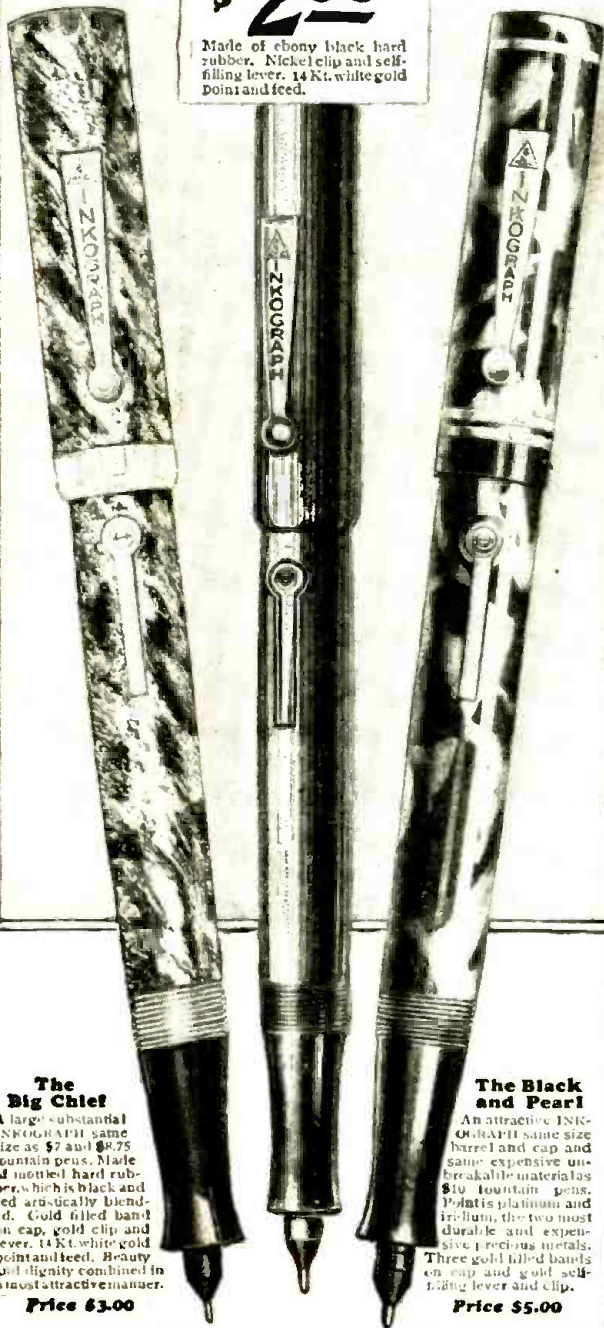

The Big Chief
A large substantial INKOGRAPH same size as \$7 and \$8.75 fountain pens. Made of mottled hard rubber, which is black and red artistically blended. Gold filled barrel and cap, gold clip and lever, 14 Kt. white gold point and feed. Beauty and dignity combined in a most attractive manner.
Price \$3.00

The Black and Pearl
An attractive INKOGRAPH same size barrel and cap and same expensive unbreakable materials \$10 fountain pens. Point is platinum and iridium, the two most durable and expensive precious metals. Three gold filled bands on cap and gold self-filling lever and clip.
Price \$5.00

FREE 10 DAYS TRIAL

INKOGRAPH
PENCIL POINTED FOUNTAIN PEN

A New Idea a distinctly different self-filling fountain pen that writes with ink like a pencil. It does any kind of writing—**instantly**—on any kind of paper, **even wrapping paper**. Better. Smoother. Without a miss, skip or blur. Has the advantage of a pen and the ease of a pencil.

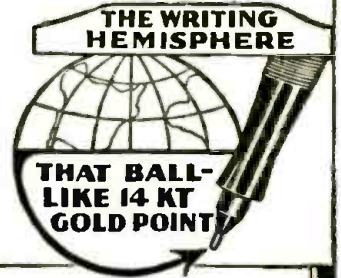

FRANKLIN SURETY CO. Assets over \$1,000,000. GUARANTEES fulfillment of all promises made in this AD.

It works like a charm—with a light, smooth easy glide that **actually** improves your handwriting. **Makes 1 to 4 clear carbon copies** and your originals in **ink**. Ideal for salesman's orders, private correspondence, office, sales, billing or other records. **Draws lines to a ruler**. Not a smudge or blot. The

hard smooth ball-like point cannot spread, bend or break. **Let anyone use it**. They cannot injure or distort it. Patent automatic feed prevents point from clogging. **And it never leaks**. Beautifully made of finest materials. Has safety screw cap, self-filling lever and clip. It is the equal of pens selling at a much higher price, and it's **FREE** to try for 10 days. No obligations. Simply send the coupon along.

WHAT THEY SAY OF IT!

I have been Money Order Clerk in the P. O. for twenty years and this is the best pen I have ever used.—*John O. Fulenwider, Monroe, North Carolina.*

Your Inkograph is a delightful surprise. The touch is velvety, the flow smooth and its performance altogether satisfactory.—*Stoney Adams, Rock Hill, South Carolina.*

You have one of the best writing instruments I ever used regardless of price. I use the lowest grade stationery and there is never a blotch or scratch because of its round smooth point. It is a wonderful invention.—*H. L. Orley, Albano, Va.*

Am a bank teller. Can pick up Inkograph any time in any position it writes immediately all words and numbers the same. Try and do it with any other pen. Can honestly say I never found a pen so easy and tireless to write with.—*C. H. Storey, Allentown, Pa.*

Am tickled skiny. It's a darling. can make carbon copies of orders and send original in ink to factory instead of penciled sheet.—*A. Watson, Elgin, Ill.*

I am determined to use no other pen in my work. If they only knew the comfort of writing with this pen, every author in the world would. I am sure, get one. "Cheerio."—*Count Louis Hamon, London, England.*

Eight years or more ago. I purchased an Inkograph, which has been in almost constant use during that time. This is rather remarkable, inasmuch as I had many fountain pens from cheap to expensive, but none compares with the Inkograph which is as good and ready to serve as when I purchased it.—*Horrie Baxter, Great Neck, L. I.*

Writes smoothly. Like point was greased. Makes no difference what kind of paper. Fine for shipping tags.—*E. A. Simma, Jersey City, N. J.*

I must write and express my appreciation to thank you for giving the public the opportunity to use so wonderful a writing instrument. In my own work, inventing, I must jot down my thoughts and ideas very quick and I find my Inkograph my first aid, which never fails.—*B. L. Henry (Ladsy Edison), New York.*

Have improved 50% in my hand writing since using your Inkograph.—*J. R. Reed, Louisville, Ky.*

You can see the point in it for insurance men—for you can spread this news but not that point.—*George E. Miller, West Philadelphia, Pa.*

In my opinion there isn't a better pen on the market regardless of price.—*D. J. Herndon, Lafayette, La.*

We intend to use the Inkograph generally in the office. It makes a splendid carbon on 20 lb. paper.—*Bernard Gloetker Company, Pittsburgh, Pa.*

Take Advantage of Our FREE 10 Days Trial Offer

and join the many thousands who tell us that regardless of price the INKOGRAPH is the best writing instrument they have ever used.

INKOGRAPH COMPANY, Inc.

World's Largest Pencil Pointed Fountain Pen Manufacturers
163-69 Centre St., New York, N. Y.

DEALERS

Stationery Stores, Drug Stores, Department Stores, etc., send for our catalog and trade prices.

SEND NO MONEY

When Ordering Inkograph Put X After Style Desired

- \$2.00** Also mark X Here if you prefer ladies' size with ring on cap to be carried on ladies' sautoir or man's watch chain.
- \$3.00**
- \$5.00**

AGENTS

Send for INKOGRAPH or FREE sales plan booklet. Sell on sight, no investment, immediate commissions.

Your name and address are sufficient. If within 10 days you are not entirely satisfied that the INKOGRAPH is the handiest and smoothest pen you have ever used, regardless of price, return it and we will refund your money.

NOTE: When remittance accompanies order INKOGRAPH will be sent postpaid. Prices outside U. S. A., \$2.00 styles, \$3.50; \$3.00 styles, \$4.00; \$5.00 styles, \$7.00 and remittance must accompany order.

INKOGRAPH CO., Inc., 163-69 Centre St., New York
You may send me INKOGRAPH, I will pay postman \$ plus postage on delivery.

Name _____

Address _____

City _____ State _____

Illustrations Actual Size

Read what BIG money these fellows have made in the RADIO BUSINESS

\$375 One Month Spare Time



"Recently I made \$375 in one month in my spare time installing, servicing, selling Radio sets. And, not so long ago, I earned enough in one week to pay for my course."
EARLE CUMMINGS,
18 Webster St., Haverhill, Mass.

\$1597 In Five Months



"The N. R. I. is the best Radio school in the U. S. A. I have made \$1597 in five months. I shall always tell my friends that I owe my success to you."
HENRY J. NICKS, Jr.,
302 Safford Ave.,
Tarpon Springs, Fla.

\$1164 Spare Time Profits



"Look at what I have made since I enrolled, \$1,164—money I would not have had otherwise. I am certainly glad I took up Radio with N. R. I. I am more than satisfied."
HENRY R. HEIKINEN,
123 W. Erie St., Chicago, Ill.

Over \$1000 In Four Months



"My opinion of the N. R. I. course is that it is the best to be had at any price. When I enrolled I didn't know a condenser from a transformer, but from December to April I made well over \$1000 and I only worked in the mornings."
AL. JOHNSON,
1409 Shelby St., Sandusky, Ohio.

I will show you too how to start a spare time or full time Radio Business of Your Own without capital



Radio's amazing growth is making many big jobs. The world-wide use of receiving sets and the lack of trained men to sell, install and service them has opened many splendid chances for spare time and full time businesses.

Ever so often a new business is started in this country. We have seen how the growth of the automobile industry, electricity and others made men rich. Now Radio is doing the same thing. Its growth has already made many men rich and will make more wealthy in the future. Surely you are not going to pass up this wonderful chance for success.

More Trained Radio Men Needed

A famous Radio expert says there are four good jobs for every man trained to hold them. Radio has grown so fast that it simply has not got the number of trained men it needs. Every year there are hundreds of fine jobs among its many branches such as broadcasting stations, Radio factories, jobbers, dealers, on board ship, commercial land stations, and many others. Many of the six to ten million receiving sets now in use are only 25% to 40% efficient. This has made your big chance for a spare time or full time business of your own selling, installing, repairing sets.

So Many Opportunities You Can Make Extra Money While Learning

Many of our students make \$10, \$20, \$30 a week extra while learning. I'll show you the plans and ideas that have proved successful for them—show you how to begin making extra money shortly after you enroll. G. W. Page, 1807-21st Ave., S., Nashville, Tenn., made \$935 in his spare time while taking my course.

I Give You Practical Radio Experience With My Course

My course is not just theory. My method gives you practical Radio experience—you learn the "how" and "why" of practically every type of Radio set made. This gives you confidence to tackle any Radio problems and shows up in your pay envelope too.

You can build 100 circuits with the Six Big Outfits of Radio parts I give you. The pictures here show only three of them. My book explains my method of giving practical training at home. Get your copy!

I Will Train You At Home In Your Spare Time

I bring my training to you. Hold your job. Give me only part of your spare time. You don't have to be a college or high school graduate. Many of my graduates now making big money in Radio didn't even finish the grades. Boys 14, 15 years old and men up to 60 have finished my course successfully.

You Must Be Satisfied

I will give you a written agreement the day you enroll to refund your money if you are not satisfied with the lessons and instruction service when you complete the course. You are the only judge. The resources of the N. R. I. Pioneer and Largest Home-Study Radio school in the world stand back of this agreement.

Get My Book

Find out what Radio offers you. My 64-page book, "Rich Rewards in Radio" points out the money making opportunities the growth of Radio has made for you. Clip the coupon. Send it to me. You won't be obligated in the least.

Address

J. E. Smith, Pres.
Dept. OCY

National Radio Institute
Washington, D. C.

This coupon is good for a FREE copy of my Valuable Book, Mail it NOW!

J. E. Smith,
President,
Dept., OCY
National Radio Institute, Washington, D. C.

Dear Mr. Smith: Send me your book. I want to know more about the opportunities in Radio and your practical method of teaching at home in spare time. This request does not obligate me to enroll and I understand no agent will call on me.

Name..... Age.....
Address.....
City..... State.....

This Book points out what Radio offers You Get a copy!



Short-Wave Opportunities

By Hugo Gernsback

DURING the past two years there has been greater activity in short-wave radio, perhaps, than in any other branch of the radio art. While short waves themselves are nothing new on the radio horizon, yet it is most interesting to note that the general public is, at last, becoming aware of the fact that there are such things as short waves.

From 1908 till 1921, radio was a sealed book, so far as the public at large was concerned. Then, when broadcasting started its triumphant progress in 1921, the general public became interested, and a tremendous boom in radio followed.

It seems certain that we are to see history repeated, so far as the short-wave receiver is concerned.

Until quite recently, it was not possible for the untrained layman to buy a short-wave set and operate it himself; and, indeed, until a few months ago it was not possible to buy an A.C. short-wave set.

These conditions, however, are being overcome very rapidly; and the time is now here when the public at large is beginning to ask questions about the possibility of listening in to short-wave stations thousands of miles away.

Until very recently, it was necessary to use the headphones when listening to short-wave programs; but, during the last year or so, it has become possible to bring in, on the loud speaker, the distant programs on the short waves, just as clearly as with the regular near-by broadcast programs.

It is no longer a novelty for people in America to listen in directly to 2L.O. of London (over 5SW of Chelmsford) or to P.C.J. in Holland; or even to a number of Japanese and Australian stations from eight to ten thousand miles distant.

Such things are everyday occurrences today; and a recent rebroadcast of European programs—which were received in America on short waves and retransmitted on American broadcast waves by the National Broadcasting Co. and its associated networks—has aroused the general public, as perhaps nothing else did that has happened in radio in recent years.

Of course, it will be many years before there will be hourly rebroadcasting by our own broadcast stations of the foreign programs; and it is doubtful that this feature will ever become quite general. In order to rebroadcast a program with faultless quality, atmospheric conditions must be absolutely right, and electrical conditions must be ideal.

But the man who operates his own short-wave set does not require 100% perfect reproduction in his programs and, indeed, it gives him a far greater thrill to tune in foreign programs directly on his own set than to listen to rebroadcasts over his regular set.

But the important message, which I would like to broadcast to all professional radio men and Service Men, today, is the following:

There are now available on the market either ready-made short-wave sets or sets in kit form, which can readily be sold to the public during the coming year. It seems quite likely that none of the large set manufacturers will attempt to sell short-wave radio sets on a large scale, as they do with regular broadcast receivers; and it is here that the professional radio and Service Man can reap his harvest. All that he requires is a good set which, when properly demonstrated to a prospect, will almost invariably result in a sale.

In other words, when the Service Man or radiotrician makes a call on a customer, he should find out by tactful questioning if his prospect is interested in receiving foreign programs from Europe or from other parts of the globe.

The important point to mention is that the type of set needed for this purpose is quite low in price, considering everything, and that a demonstration will be gladly made in the prospect's own house. This is also comparatively simple; because the prospect has already an antenna and ground and his own batteries to operate the short-wave set. In case the set owner has an A.C. receiver, an A.C. short-wave model will, of course, have to be used by the salesman.

If the demonstration is well made, there is no question but that the professional radio man can dispose of quite a good many short-wave sets.

Or, if it is not desired to sell the prospect in his own home, it is then a good idea for the professional man to rig up a set on his own premises, and send out invitations to his prospects to come and listen in to foreign short-wave programs, at certain times of the day. This is always a good drawing card, and many sales can be made in this manner.

At the present time, it is still necessary (with the majority of short-wave sets) to plug in different coils for the different wavelengths. But radio history is being rapidly made and, in a forthcoming issue of *RADIO-CRAFT*, we will present to our readers an entirely new development whereby it has now become possible with a single set of inductors—which need never be removed from the set—to tune in to all wavelengths between 20 and 200 meters. This, by the way, is one of the biggest radio developments in many years; the feature will be exclusive with *RADIO-CRAFT*.

It should be noted that the surface of short-wave possibilities has as yet not been scratched; and that, sooner or later, we will certainly have a real boom in short-wave radio. Now is a good time to prepare for it, and lay the groundwork for what is to come.

Service Men's Department

Edited by JOHN F. RIDER

ONE of the interesting—if not the most interesting—high lights of radio service work is that nothing can be taken for granted. Each diagnosis for trouble, be it simple or complex, is individual in itself.

Take, as an example, the voltage divider employed in a "B" eliminator. It is common practice to employ the "bridge" type of unit; that is, the resistance network across the output of the filter system, with taps at certain points to provide certain fixed voltages. Yet it is unsafe to assume that all radio receivers employ such voltage-divider systems; because quite a few employ the parallel arrangement, where a separate resistance is connected between the maximum "B+" and the tube or tubes to be operated at a certain value of plate potential.

It is quite common to supply grid bias for the output tube by means of a fixed resistor connected between the center tap of the filament circuit and the grid return lead, which is also "B-". Yet it is unsafe to assume that all are connected in this manner; because some popular receivers employ a separate resistor in the "B" eliminator system as the source of bias for the output tube.

One would naturally assume that, if a voltage-divider resistor is used in connection with a "B" eliminator, and this resistor is tapped at certain points for the voltage required in the receiver, the tap intended for the detector connects directly to the unit located in the plate circuit of the detector tube. Yet measurements of the supposed "detector" voltage at the divider, and at the tube plate, show a difference greater than that which should be due to the drop across the transformer primary in the plate circuit. The difference is due to a drop across a special resistor located in the detector plate circuit of many receivers. This resistor is used to drop the voltage to the value required for the detector tube, and is external to the voltage-divider.

The fact that two output terminals are provided inside the receiver housing does not signify that an output coupling unit is enclosed within the receiver. Quite a few A.C. receivers designed for operation with 71- or 71A-type tubes are equipped with two output binding posts, but not with output coupling units. The (magnetic) speaker tips are plugged into these terminals and, as such, are directly in the plate circuit of the output tube.

Defects do not occur at the most accessible points in an installation. Several instances have been found where short circuits were located within the connector plug employed to couple a dynamic speaker to the receiver proper. Such plugs have four or five contacts whereby several circuits are closed. An apparent defect in a speaker system need not be located within the speaker proper. Check the plugs!



MR. JOHN F. RIDER is one of those radio authorities who has the knack of bringing engineering down out of the clouds—or at least out of the laboratory—and putting it to work for the Service Man. Each month he will contribute practical articles, in addition to passing upon all the suggestions and experiences offered to this department by its readers.

The ends of shielded cables frequently cut through the wire insulation and, when jarred by vibration of a receiver during operation, will cause intermittent shorts.

Though it is a fact that a very large number of power packs employ the 80-type rectifier tube with similar capacity values in the filter system, the D.C. resistance of the chokes employed in the filter is not always the same. Investigation among a large number of manufacturers shows that such resistance values vary from about 200 to about 1,000 ohms.

The fact that one chassis put out by a manufacturer utilizes chokes rated at, say, 330 ohms D.C. resistance does not mean that the same type of choke is incorporated in the "B" supply unit employed in conjunction with another receiver chassis; despite the fact that the rectifier tube is the same in both instances.

Filter chokes employed in A.C. "B" eliminators are not the same as those employed in the eliminators of D.C. receivers. Because the frequency to be filtered is much higher, it is possible to employ smaller values of inductance; and, since the current flow through such chokes is much higher than in A.C. receivers, the D.C. resistance of the winding is much less. The D.C. resistance of such chokes varies from a fraction to about 30 ohms.

All 26-type A.C. tubes do not secure their grid bias by means of a resistor located in the filament center tap—"B-" grid return circuit. Quite a few receivers still employ the old "B" eliminator standby.

All radio receivers have not reached the standard of design where it is possible to

secure a high degree of tone quality with low value of power output. In many good receivers excellent quality is available with high gain level; but the reproduction falls off when the volume is reduced. The fault is in the speaker and not in the set.

The fact that a unit is new does not mean that it is perfect. Quantity production is such that a few defective units slip by now and then. We make particular reference to phonograph pick-up units; it is possible that they may be defective when purchased.

The conventional filter system employed in a "B" eliminator is of the "pi" type, with two chokes in series with the line and three condensers across the line. In some of the new receivers, however, the design of the filter system has been changed; the structure is still the same but the number of elements in the system have been changed. In some, one of the chokes is shunted by a capacity; thus forming a parallel resonant circuit in series with the line. Filter systems are undergoing changes in design. Quite a few do not employ the input capacity.

The fact that an audio coupling unit is contained within a metal case equipped with four output terminals (indicated as "P," "B," "G" and "F-") does not signify that the unit is a transformer. Quite a few receivers arrange impedance-coupled units in such fashion. Furthermore, the fact that an audio coupling unit bears more than four terminals does not mean that it is a push-pull transformer. Several receivers are equipped with single units housing two separate transformer windings connected into different audio stages.

The fact that a transformer consists of two separate windings, inductively coupled to each other, does not mean that the two circuits are isolated from each other. Bear in mind that the grid return lead terminates at the "B-" terminal, and that the other side of the "B-" terminal (namely the "B+") terminates at the primary winding of the same transformer. Thus continuity testing cannot be done unless the leads to the transformer are disconnected.

The man who takes for granted that a tube is not shorted will eventually pay the cost of several new meters. Short circuits are common among tubes which have been handled, inserted and withdrawn from sockets. Test all tubes for short circuits before inserting into a regular tube tester.

The fact that perfect continuity is available through a winding, as determined by means of a voltage test, does not mean that the winding is perfect; it may be shorted.

The fact that a receiver operates, although poorly, does not mean that its circuit continuity is satisfactory. Open plate circuits in the radio-frequency amplifiers will not always stop operation of the receiver. Open plate-circuit resistors will impair performance, but will not interrupt operation.

Leaves from Service Men's Note Books

The "Meat" of what our professionals have learned by their own practical experiences of many years

By RADIO-CRAFT READERS

KEEP YOUR WATCH AWAY FROM THE DYNAMIC

By George H. Haby

I HAVE experienced something, while repairing sets with dynamic reproducers, that should be published to warn other Service Men. I temporarily spoiled my good watch, through magnetization of its steel parts in the flux thrown off by the field windings of a Kolster speaker. In a test, I found the magnet affected a compass some distance away, directly in front of the reproducer.

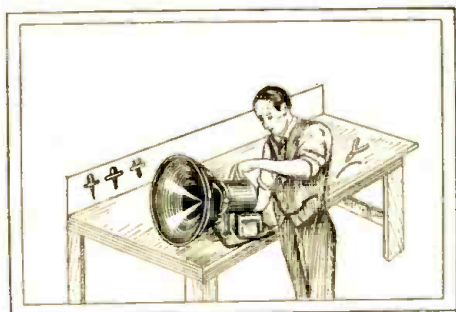

Fig. 1

When a service man is working on a dynamic, his watch is close to the field coil. If a current were turned into the windings, it would magnetize the watch.

(Electrical workers have long known the necessity of keeping a sensitive watch away from the fields of motors and generators. The electrodynamic reproducer introduces into radio a piece of apparatus with strong flux; and, while the user of the set does not come close enough to it to experience this trouble, the Service Man should be careful to keep his watch away from the field windings of the reproducer while testing.—Editor.)

TESTING RADIO RECEIVERS

By C. Washburn, Jr., (BS., E.E.)

WHEN answering a service call, I carry with me a Jewell No. 199 set analyzer and a small portable tool-box which contains the instruments and supplies described below.

Upon arriving at the customer's house I derive as much information as possible about the action of the set by questioning the customer. I then turn on the set to see that the tubes light, and notice whether there is any sound in the speaker.

If the set is battery-operated, I test the batteries with the set "off"; using a storage-battery discharge meter with a low-resistance, 0-50 voltmeter. The latter affords a test of the "B" batteries under load, due to the low resistance of the meter. The storage battery meter precludes the danger of spilling acid incurred when using a hydrometer.

If the set is electric, I insert the plug of my set analyzer in one of the sockets of the

set and read the filament voltage. If this is normal, I know that the line-voltage is O. K. If not normal, I then test the line voltage with the A.C. voltmeter in the analyzer. If this test shows normal condition, I substitute the phones for the speaker, as a check on the speaker. I then test the aerial and ground for a short with the continuity tester. The suggested routine for testing is tabulated as follows

TOOLS

Lineman's pliers, long-nosed pliers, side cutters, soldering iron and stand, large and small screwdrivers, storage-battery discharge meter (not a hydrometer); 0-50 low-resistance voltmeter; pair headphones.

ACCESSORIES

Tubes: one '01A, one '27, one '80, one '71A; one 2-mf. 300-volt filter condenser; one .00025-mf. grid condenser with clips; grid leaks; one ground clamp; box of assorted screws, soldering lugs; roll of hookup wire; coil of aerial wire.

INFORMATION FROM SET OWNER

- Age of set?
- General performance?
- Condition prior to defect?
- Changes made in set?

TESTS ON BATTERY SET

- Tubes light?
- Sound from speaker?
- Test batteries;
- Test circuit;
- Test tubes;
- Repair.

TESTS ON A.C. SET

- Filament voltage?
- Line-voltage?
- Check speaker;
- Aerial and ground;
- Tube voltages—plate-grid?
- Continuity tests.
- Repair.

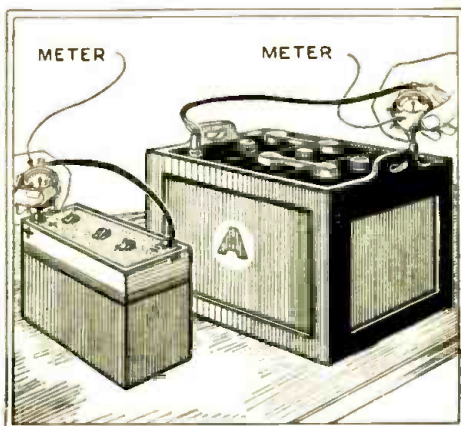

Fig. 2

Mr. Washburn uses cheap, low-resistance meters to give a load test of batteries, before going over the set with his analyzer.

AN UNUSUAL COMBINATION

By Stanley I. Hough

AN almost unique experience, I believe, was that which I enjoyed(?) when called upon to service a monstrosity which combined a fine grand piano, a phonograph, and a radio receiver. The instrument was called the "Phonopiarad Grand," or something equally distinctive. Its design had been accomplished by someone with a great lack of radio engineering skill, but a countervailing surplus of optimistic imagination. The owner, a resident on "Millionaire

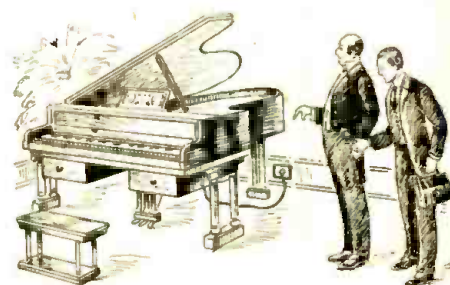

Fig. 3

Luckily, customers who require servicing jobs with silver trimmings have the money to pay for them.

Street" (Summit Avenue, St. Paul, Minn.) had paid the trifling sum of \$4,500 for this eleventh wonder of the world.

It was a grand piano of high quality, with two sliding drawers, one to the left and one to the right, which contained the receiver and the phonograph, respectively. A reproducer and power pack (such as are incorporated in the RCA 104 combination) were mounted beneath the piano, in such a manner that the opening of the speaker pointed toward the floor, and the tubes of the power unit hung downward, threatening to fall at any time to the floor. Both units had been taken from some Victor combination; but I am sure that the designing engineers in their most fanciful moments had never imagined the use to which the material would be put. The receiver was of the "28" type, comprising eight three-volt tubes in a super-hot hook-up, with center-tapped loop.

I decided to tackle the radio problems first. The designer, being ignorant of the nature of a loop antenna, had designed one of only four or five turns to fit a very limited space. I replaced this with an inductor; making it necessary to utilize an aerial-and-ground system. This was installed by house wiring experts; for the customer was one of those who insist on specialization and expert service, and are willing to pay the price. The connection was made to an outlet at the rear of the piano.

The next problem was to relocate the power unit so that the tubes would be in

an upright position, out of sight, yet accessible for servicing. This required the construction of a special hinged hanger, which could be lowered for service work.

Since the speaker produced disturbing harmonics in parts of the piano itself, an unusual amount of experiment with sound-insulating materials was necessary, to correct the condition without producing "echo chamber" effects that would injure the piano's tone. This was finally done; a rattle in the speaker's cone was finally eliminated by installing a new felt-edge cone, after vainly trying to re-center the old one.

Last, but not least, came interference. This was finally reduced, sufficiently to satisfy the customer, by installing special filters, one on an oil burner, and one on a small motor.

The phonograph was checked, and replacement of the centering rubbers was the only thing found necessary.

With a sigh of relief, I gathered my tools—only to find I had sighed too soon. The butler stopped me at the door, to inform me that the antenna outlet plug must be changed to match the colors of the room before the work could be accepted as complete. A few days later, I installed a silver-plated outlet plate.

Can you beat it? I would be very much interested to hear from anyone who has had the opportunity to service any such outfit as I have described.

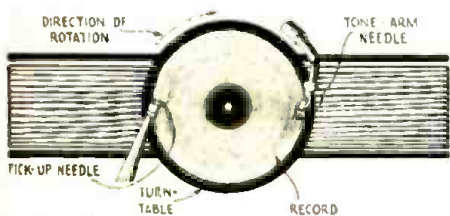

Fig. 4

This use of the same disc for radio and phonograph at once is not only amusing, but a test of quality.

A RADIO-PHONOGRAPH KINK

By Louis B. Sklar

HERE is a very novel scheme of playing the radio and phonograph simultaneously. Anyone having an electric pick-up and a phonograph can perform this stunt without difficulty, as shown above.

Looking at the layout, you see that the pick-up needle is at one side of the record; while the tone-arm needle is exactly opposite. When the record starts to rotate, music will be heard coming from the phonograph as well as from the radio speaker. The music from the two speakers will be slightly out of synchronism, because the two needles are not on the same point of the record; even though they are placed in the same groove. This produces an effect as if one instrument were playing and the other accompanying it; it is particularly noticeable on a voice record.

Any radio fan who has the necessary equipment will find this stunt very amusing. Radio Service Men will find this scheme a very good attraction in selling radio pick-ups.

TESTING THE '80 ON 110-VOLT D.C.

By Jack Sadowsky

WHERE the Service Man finds it necessary to test a full-wave rectifier tube

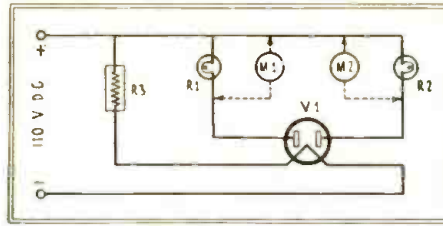

Fig. 5

Used in this way, 10-watt lamps will serve as crude meters for the Service Man who has not an analyzer fitted for '80 tubes.

of the '80 type, and alternating current for the purpose is not available, or milliammeters with high ranges are not available (the usual positions for such 75-ma. scale meters are indicated at M1 and M2 in Fig. 5) the writer suggests the use of 10-watt lamps. These light up, showing the approximate amount of current passed by

WHAT IS THE COMMONEST TROUBLE IN THE R.F. AMPLIFYING CIRCUIT?

RADIO-CRAFT especially invites its readers to send in their answers to this question during the coming month, so that we may have, as it were, an open forum on the subject in our May issue. Each month a different subject for discussion will be propounded.

each plate of the '80. With a little practice, and a comparison or two with a milliammeter, a good idea will be obtained of the condition of the tube. The 10-watt lamps are indicated at R1 and R2.

Filament current of the correct amount for the tube is obtained through resistor R3, which may have a value of 60 ohms. Otherwise, two 32-c.p. carbon-filament lamps, or a 240-watt lamp bank, may be used.

MAJESTIC '9P6' CONDENSER PACK

By J. A. Shafer

WHEN testing the power pack in the Majestic '9P6,' for shorts in the condenser bank, a reading will be obtained (in the earlier models) between the second and the fifth taps. This is due to a choke coil,

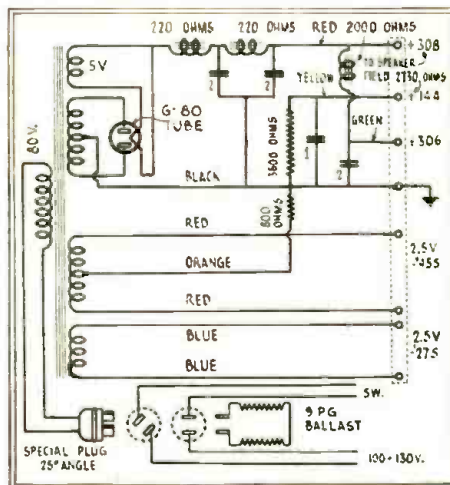

Fig. 6

The schematic circuit of the earlier Majestic '9P6' power pack, showing the choke between detector and power-amplifier tap.

which is mounted inside the condenser can, and connected between these two taps.

In the later models, this choke has been replaced by a resistor. In case of an open in this choke or resistor, there will be no plate voltage at the detector tap.

REPAIRING MAGNETIC SPEAKERS

By Elden L. Cherry

THE independent Service Man, who is called upon to repair all kinds of sets, is likely to have among his customers many who are still using cone- or horn-type loud speakers, of the designs popular a few years back. Most of these were intended for use with sets with low output current, being wound with 40-gauge wire; and an open or burnt-out coil is a common difficulty. You may consider such speakers obsolete; but to tell the owner of one, "Your speaker is not worth repairing," does not add to your profit or prestige. In fact, satisfying the customer with a prompt and economical repair job is just the kind of work that is likely to cause him to recommend you to his friends.

At first, it might appear too troublesome a job to be worth bothering with; but, with the improvised device shown in the sketch, I have found it to be a comparatively simple operation. It is also a profitable one; since a job for which your customer will readily pay \$1.50 or \$2.50 can be done in about

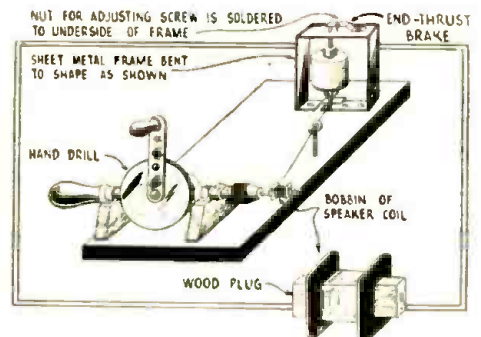

Fig. 7

Mr. Cherry quickly rewinds a magnetic speaker's armature coil in this manner. Extra care must be taken to correctly "pole" the repaired coil.

thirty minutes. The winding of the coil itself requires only about five minutes. The wire costs nothing; since it can be obtained from the secondary of a defunct audio transformer.

Of course, speakers of too old a type, having a unit built like a headphone, are not worth bothering with; but the ones in most common use are usually of the balanced-armature type (Baldwin, Utah, etc.) which are quite easy to repair. These have a single coil wound on a bakelite or fiber bobbin. After removing this from the unit, a wood plug is fitted to the hole as shown; and a small rod is passed through the plug and held in the chuck of the hand drill, as shown. The bobbin need not be centered exactly.

The audio coil in this manner is also mounted on a wooden core and a large brad in each end serves as a shaft. This coil is heavy and should be centered as nearly as possible; however, mounting it on a vertical axis avoids most of the trouble due to any lack of balance. This also allows the paper between the layers of wire

(Continued on page 467)

Operating Notes for Service Men

Some of the simplest things cause the most trouble. The Service Man says to himself: "I ought to have known that; I won't tell anyone how dumb I am." Mr. Freed tells on himself.

By BERTRAM M. FREED

THE Sparton "301" and "931DC" employ six type-184 3-volt Carbon tubes in series; if one of the tubes is withdrawn, the pilot light will "blow." With the pilot light either "shot" or removed, the filament voltage on the 184s will rise. Do not replace the tubes in a Sparton with R.C.A. or Cunningham tubes, or similar types; because the heater voltages in the set are too high. Therefore, replacing the burnt-out 184s with '27s will cause trouble.

In the Stromberg-Carlson screen-grid models, what may appear to be a fixed condenser in the plate circuit of the detector is, in reality, an R.F. choke L1 housed with two .0005-mf. fixed condensers C1, C2, whose center connection is grounded. The other side of each condenser is connected to one end of the choke; the combination serves as a low-pass band filter. The writer had the experience of testing one of these models, and obtaining a "short" reading across the

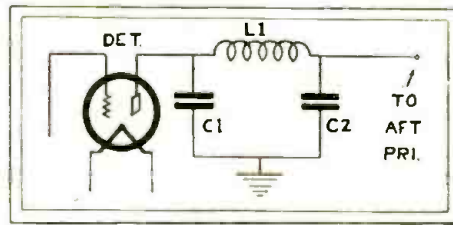

Fig. 1

Many modern sets have a special R.F. filter in the detector plate circuit; the schematic of this portion of a Stromberg-Carlson set, for example, is shown above.

ment rheostats or potentiometers controlling R.F. plate voltages.

The Fada "16AC" and "20AC" are alike except for the type of reproducer to be used; the former model uses a magnetic, and the latter is designed for use with a D.C. dynamic, for the field winding of which it supplies current. Since the set itself contains the output transformer, only a Fada D. C. dynamic reproducer can be advantageously used with the "20AC."

When replacing volume controls in a Fada A.C. model, care with respect to the connection of the leads must be exercised. The shift is invariably connected to the chassis.

It may be found that Arcetrons 127 tubes of an early design will cause oscillation in the Fada "16," "20" and "50" models. The reason is that these sets were neutralized with Radiotron 227s, whose characteristics are somewhat different.

Radiolas and Reproducers

The "30A" Radiola is now being sold in large numbers, by many dealers. The writer has come across quite a number, of this model, which are noisy; so much so, in fact, that the slightest jar will cause the set to emit sounds as from the nether regions. To remedy this, remove the chassis from the cabinet, and clean the rheostats with steel wool; make both resistance strips clean and shiny, and wipe them with a clean rag.

The "44AC" and "46AC" Radiolas have a tendency to oscillate on high wavelengths. To remedy this trouble, adjust the com-

pensators, which are situated in front of the condenser gang. It will be necessary to remove the chassis from the cabinet, to do so.

A very difficult task, unless one knows the knack of it, is to replace the "100A" magnetic reproducer chassis in the "30A" Radiola. Many remove the large and cumbersome power plant to get at the speaker, before they discover the right method. Here it is:

Remove the front speaker grill by pulling out one side (the left side, as you face the set) and remove the screen at the bottom of the cabinet. Loosen the four screws holding the unit; and the speaker will drop out, through the opening in the bottom of the cabinet.

It is easy to adjust a dynamic reproducer which has a screw to tighten the web of the

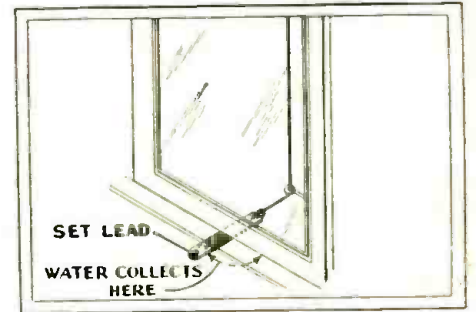

Fig. 4

The unexpected source of reduced signal volume, due to leakage from the lead-in in damp weather, illustrated above, caused much grief to Mr. Freed and his fellow Service Men.

voice-coil cone to the field magnet. If the receiver has a hum control, adjust this for loudest hum; or place aerial on the grid of the detector tube. Loosen the screw in the reproducer, to allow free action of the voice coil; and adjust the cone and coil until the 60-cycle note is heard loudest. Tighten the screw; and the voice-coil should then be found properly centered.

A fixed condenser (say .015-mf.) connected across the primary of the output transformer which feeds a dynamic reproducer will often correct what appears to be a rattle in the speaker. (Fig. 3.)

It Was All Wet

Some time ago, I was given a service problem on which most of the men in our outfit had tried their luck; the manager said it was "one of those jobs," and that I should take my turn at it. One of our customers had a Knight six-tube D.C. receiver, which he found almost inoperative after every shower, for a day or two.

I answered that it was a "pipe," and asked for plenty of aerial equipment; whereon the manager laughed, and said that the customer had already had three installations. Nevertheless, I took plenty of material, and went my way to that section of

(Continued on page 467)

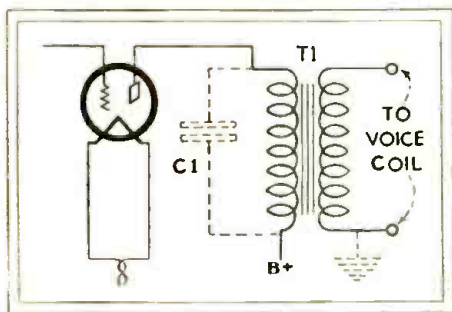

Fig. 3

"Rattle" in a dynamic coil often be corrected when the primary of the reproducer's matching transformer T1 is shunted by a fixed condenser C1 of correct capacity.

terminals of this choke. He immediately cut the "condenser" out as defective, and threw it out of a fourth-story window; only to walk down, a little while later, to recover it! (See Fig. 1.)

The "radio-phonograph" switch on the Sonora "44" should be examined, if a complaint of lack of volume is made after a week's reception. Clean the contacts of the switch.

In sets which use '26 type tubes in the R.F. and A.F. stages, with a '27 as detector, hum has often been minimized by wrapping a sheet of tin foil, or putting a metal cap, over the detector and grounding it.

Zenith and Fada Models

In the Zenith "Fifty" series (Models 52, 53, 54, 532, 542) the biasing resistor for the screen-grid R.F. amplifier has been found open several times, in the writer's experience. This resistor, indicated by yellow in the color code, has a value of 400 ohms; the biasing resistor for the push-pull stage, which is colored black, has a value of 2,000 ohms. Fig. 2 illustrates this.

Readings of plate voltages and plate current on Zenith receivers should be taken with the volume control in "maximum" position, because the controls are either fila-

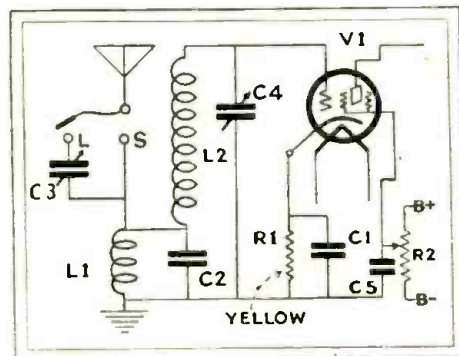

Fig. 2

Position of the biasing resistor for the screen-grid R.F. stage in Zenith radio sets of the "Fifty" series.

Servicing the Freshman "QD-16S"

A popular, early screen-grid A.C. model is analyzed here for the Service Man

By HAROLD WEILER

CONTINUING our consideration of the problems encountered in servicing popular receivers of the 1928-9 season, we come to the Freshman "QD-16S"—one of the sets which introduced the screen-grid tube to the public. It is a four-tube A.C. electric set, employing a '22 screen-grid tube (with alternating current on the filament) in a stage of tuned radio frequency; two tuned circuits couple the output of this tube to the input of the '27 grid-leak detector. Two stages of auto-former-coupled audio frequency follow; the first is a '26 and the power tube a '71A.

With this set, the most common complaint is the lack of selectivity in congested areas. This may be due to one or more of the following causes:

(1) Antenna, including aerial, lead-in, and ground wire, may be too long;

(2) The regeneration control C1 may be improperly adjusted;

(3) Tubes may be bad;

The first error is the most important; and is due to the fact that the R.F. amplification is high in proportion to the number of tuned circuits. The over-all length of the antenna, as defined above, should not exceed a hundred feet.

Secondly, the regeneration control should be so adjusted that the highest selectivity and volume are obtained.

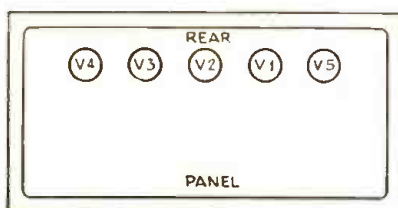

Tube layout of the Freshman "QD-16S"

Thirdly, the tube operation is critical, and the tubes should be tested.

If the receiver is noisy, first disconnect the antenna; if the disturbance then ceases, the set is not at fault. If the noise continues, it is necessary to trace further.

Rotate the volume control; if it is noisy, clean the contact arm and resistance strip. Change the grid-leak; using a 2- or 3-megohm resistor.

Use test circuit (Fig. 2) with "A" tip on orange and "B" tip on red lead of the first A.F. transformer, to see if the noise is here. Do the same with the second A.F. unit. If a transformer is found noisy, remove it and heat over a stove to dry out the moisture.

Tests in the Pack

Clicking noises may be due to dust on the condensers, chokes or transformer in the power pack.

Frying and sizzling noises may be attributed to an imperfect voltage-divider or defective rectifier. Either of these is indicated as defective by fluctuating output voltages.

If a howl (not due to a microphonic tube) is heard, a frequent cause is an open bypass condenser across the detector tap in the pack. Hum may be due to an open filter condenser, or an overload in the power pack.

An open '80 rectifier also will cause hum, accompanied by slightly lower voltage. To test the filter choke, short the two dark green leads. If the hum increases, the choke is working properly.

If the '22 tube does not light, attach the "A" and "B" tips of the meter tester (Fig. 1) to the two blue leads of the power transformer; the meter should register. If no grid bias is obtained, and the filament winding is perfect, check the grid resistor R6, by placing "A" tip on the white lead of the transformer, and "B" tip on the grounded end of the antenna coil. If the meter does not show continuity, replace with a 1,500-ohm resistor.

If the '26 tube remains unlighted, place the tester tips on the two pink leads; the meter should show continuity. If "C" bias is lacking, place the "A" tip on the black,

(Continued on page 466)

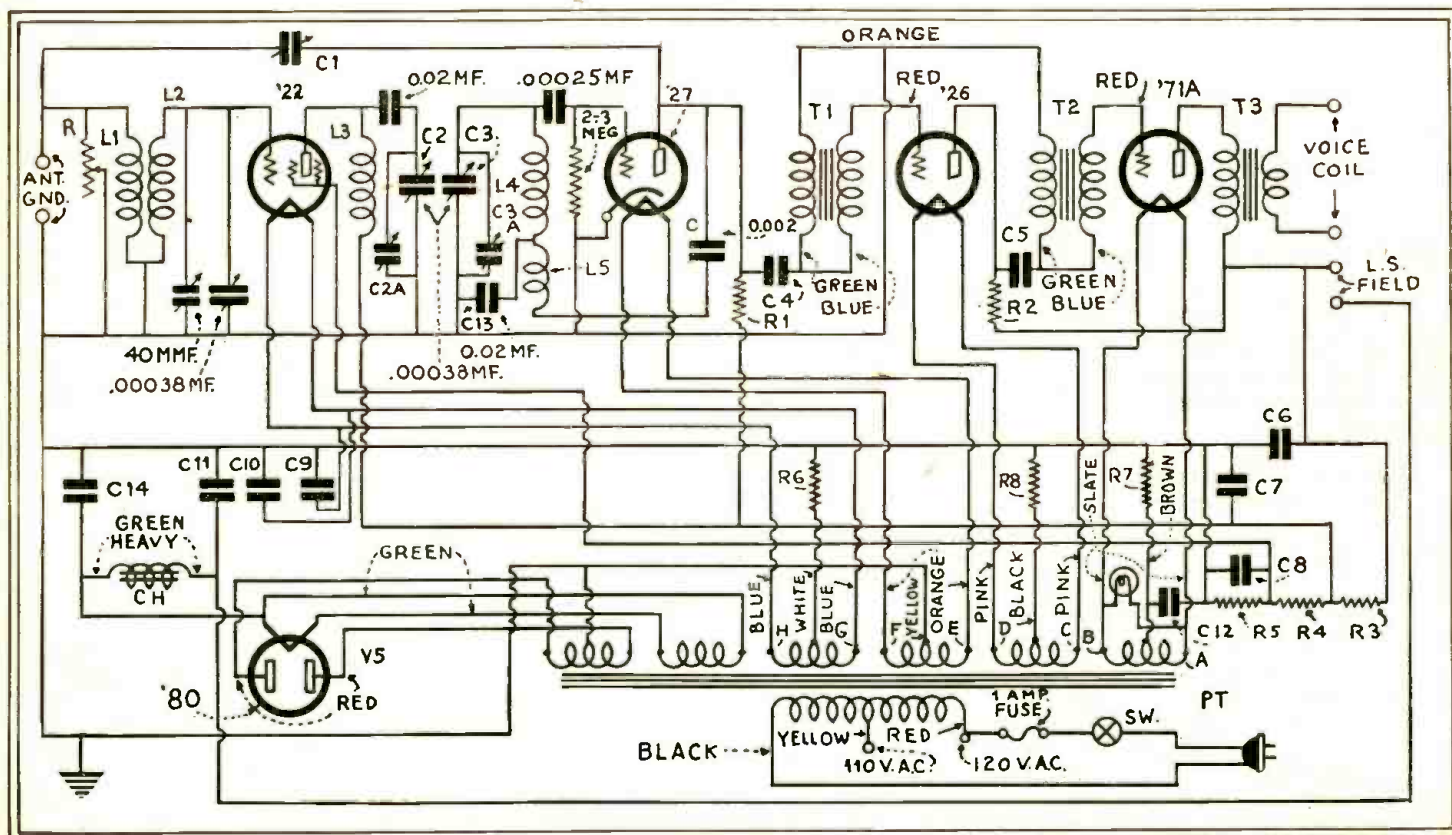

Schematic circuit of the Freshman "QD-16S" screen-grid receiver; correct coupling between L3 and L4 is an important selectivity factor in this set. Values not shown above are: C1, 35 mmf.; C4, C5, 0.25-mf. (1500 ω); C6, 2 mf.; C14, C11, 1 mf. (2000 ω); C7, C8, C12, 1 mf. (1000 ω); C9, C10, 0.25-mf. (500 ω). R1, R2, R3, R4, R5 are 40,000, 25,000, 12,500, 12,500, and 10,000 ohms, respectively

The Construction of a Radio Work Bench

Description of a versatile piece of shop furniture which may be conveniently arranged for the Radio Service Man's use

By H. L. WEATHERBY

IT is very unusual to find a man with no mechanical ability and with no desire to make things. It seems to be as human a trait for the young male of the species to desire mechanical play-things and tools, as for the girls to want to play with dolls. This tendency should be encouraged in the boy; and in adult life it may develop into one of the most interesting of pastimes and hobbies. The home workshop should be a part of every man's and every boy's home. It may occupy an attic room, a place in the basement or garage; but, wherever it may be, every man should have a place where he can tinker with parts of the family car, where he can take his radio apart and put it back together, or build one, where he can make new or repair the old furniture. In short, he ought to have a play room, but a play room that will yield marvelous returns in peace of mind and in products turned out.

The shop should be well lighted naturally and artificially, for day or night work. A basement room is usually dark and damp. Tools become rusty and the floor is usually of cement, which is hard to stand on. Then, too, edge tools which are dropped on it dull readily, and others break. In building a house one room, well lighted and ventilated, should be left for a shop.

Another feature to consider is heat, in northern climates particularly. The shop should be supplied with heat; gas, if available, should be piped to the shop; an electric light line, by all means, should be at hand; and running water is a great convenience. None of these things, however, is an absolute necessity; so do not be discouraged if

you lack some of them. The main considerations are light, ventilation, and good tools. Even the best workman cannot do good work with bad tools.

OR WHAT HAVE YOU?

WE will be glad to receive from any of our readers suggestions as to the ideas which they have found time- and trouble-saving and generally useful in the radio workshop. The bench equipment designed by Mr. Weatherby is here shown with illustrations indicating its adaptation to radio service and repair work, as well as set building and experiment.—*Editor.*

Design of Work Bench

The work bench illustrated is one which no workman, skilled or otherwise, need be ashamed of. It is sturdy and is of sufficient size to meet all ordinary demands. It has an electrical outlet for the soldering iron, glue pot, and other electrical appliances. A gas connection is mounted on the board for use with a Bunsen burner or where an electrical glue pot is not available. Ample space on the back is provided for tools. A trough is provided in the top for planes; saws may be hung on the ends of the bench. A nail-and-screw compartment box is found in a convenient place; and cabinets and drawers below furnish ample storage space for finishing materials and special tools. The

At the left, the work bench is shown equipped with meters for the Service Man's use. In this position, they will be most convenient for service testing.



Mr. Weatherby's original design for the home mechanic. Everything is conveniently located, and the tools for wood and metal working are at hand.

bench should be fitted with a good wood-worker's vise and a small machine vise. The total cost, not including equipment, probably will not exceed twelve dollars.

The material may be purchased machined to size and simply assembled at home; though it may cost slightly more if this is done. Taking for granted that a shop is just being equipped, both tools and equipment are scarce; and it will not be an easy matter to build a bench lacking proper implements with which to build it. The construction of this bench, however, is very simple and with the ordinary home tools it is easily assembled.

Bill of Lumber

Secure from the mill the following material, which should be maple or oak. Maple makes the best work bench, but a good grade of white oak runs it a close second:

- 4 pieces for legs, 2 in. x 2½ in. x 32½ in.;
- 1 piece for top, 1½ in. x 23 in. x 44 in.; this should be glued up from narrow strips, and grooves should be cut in each end for the end pieces, the grain of which runs at right angles to the top. The tool trough should also be cut in the back side and a ½ in. piece set in from the bottom with screws.
- 2 pieces for top 1½ in. x 3 in. x 23 in.; these are to have tongues cut on them, to fit the grooves in the ends of the top.

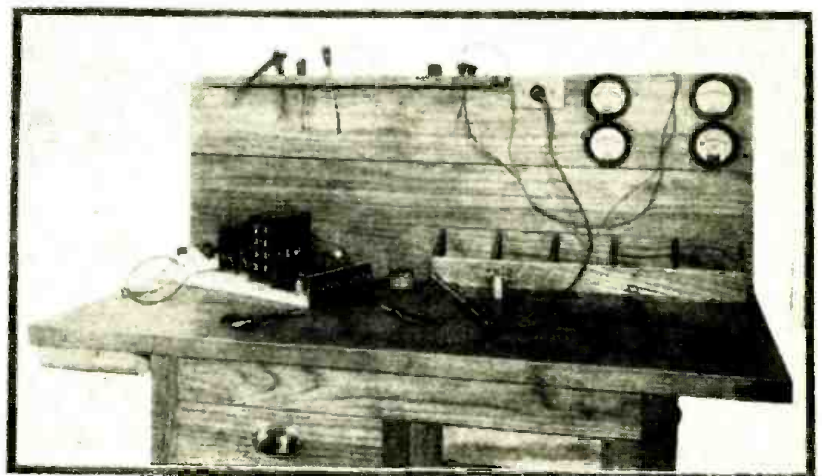

The work bench rearranged for the use of the Service Man; the radiotician's tools replace the carpenter's. The Jewell meters shown are: one A.C. "Model 78," 0-3-15-150-volt reading; and three D.C. "Model 88" with these scales—0-15-150 ma. and 0-75-volt; 0-1-10-amp.; and 0-150-300-750-volt.

- 4 pieces for long frame, 2 in. x 2½ in. x 33 in.;
- 4 pieces for end frame, 2 in. x 2½ in. x 18½ in.;
- 1 piece for tool panel, 1 in. x 18½ in. x 18 in.; this will probably have to be glued up.
- 2 pieces for ends, ¾ in. x 18½ in. x 19 in.; these are to be fastened in places with screws.
- 1 piece for back, ¾ in. x 23 in. x 29 in.;
- 1 piece for drawer front, ¾ in. x 3½ in. x 16 in.;
- 1 piece for drawer front, ¾ in. x 6 in. x 16 in.;
- 1 piece for drawer front, ¾ in. x 7½ in. x 16 in.;
- ⅝ in. soft wood for sides and backs of drawers, and ¼ in. plywood for bottoms;
- 2 pieces for door, ¾ in. x 2 in. x 19 in.;
- 2 pieces for door, ¾ in. x 2 in. x 12 in.;
- 1 piece for door, panel ¼ in. x 9 in. x 16 in.;
- 1 piece for partition, 1 in. x 21¾ in. x 22 in.; this may be common pine faced with an oak strip on the front edge;
- 1 piece for bottom, ½ in. x 18 ½ in.;
- 2 pieces for drawer partitions, 1 in. x 2½ in. x 17 in.;
- Scraps for drawer slides;
- 6 pieces for nail box ½ in. x 3½ in. x 4 in.;
- 1 piece for nail box, ½ in. x 2 in. x 24¼ in.;
- 1 piece for nail box, ½ in. x 4 in. x 24¼ in.;
- 1 piece for tool holder 1 in. x 1½ in. x 28 in.

All this wood should be surfaced and sanded, if it is possible to have this done. However, if the frame of the bench and the top can be assembled, a vise may be attached and the job finished on the bench itself while under construction.

For assembling of the frame, through mortises are cut in the legs, for the long or front and back rails. The short or end rails are cut perfectly square and to the right length, and held in place with long bolts (as the drawings show) which also hold the tenons in the long rails.

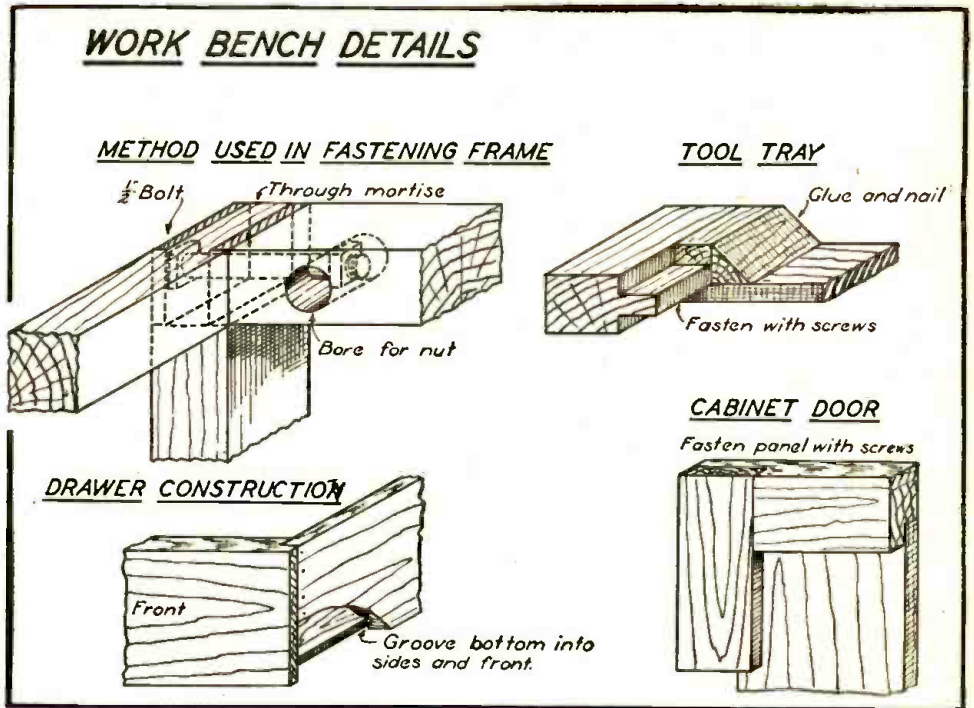

The joints used in framing the bench are shown here in such a manner that their exact nature may be determined. The construction is simple; and the worker who has not the facilities for doing this joinery can frequently purchase the woodwork ready finished for assembly.

After the frame has been securely bolted together, the top is fastened down with long screws through the end and side rails. After this the vise may be mounted on the left end, which projects slightly farther than the right end to care for this. The bench then may be finished up at one's leisure and at home.

The construction and fitting of all parts are fully shown in the details. Pulls, hinges, and lock should be set; and then the bench should be carefully sanded, given a coat of light filler, and varnished with one or more coats of good varnish. The bench, if carefully constructed of good sound hardwood, will be a very strong, serviceable piece of equipment.

Equipping the Shop

With the bench constructed we should turn our attention to equipping the shop. Nearly everyone has a few of the common tools; but we will give a rather complete list, to select from as pocketbook and desires suggest. The prices given are only approximate, but they will serve as an indication of what one should pay.

Block plane	\$1.50
Jack plane	3.25
Marking gauge50
Try Square50
Back saw	1.75
Hand crosscut saw	2.00
Hand rip saw	2.00
Wood vise	4.00
Machine vise	5.00
¼ in., ½ in., ¾ in., 1 in. chisels	4.00
Dividers50
Spokeshave	1.00
Square	1.00
Rule10
Duplex oil stone50
Cabinet scraper90
Pliers25
Bit brace	2.00
Set of bits	2.00
Nail sets20
Hammer90
Mallet50
Countersink20
Hack saw35
Coping saw25
Files25
Screwdriver25
Automatic drill	1.50
Glue pot	1.75
Bunsen burner75
Emery grinder	2.00

The list given here will cost approximately forty dollars. It can be added to as occasion demands; wrenches, punches, drills, snips, soldering iron, etc. It is largely a question of the nature of one's work and what he may wish to invest. On the other hand, ten dollars spent on tools will yield wonderful returns.

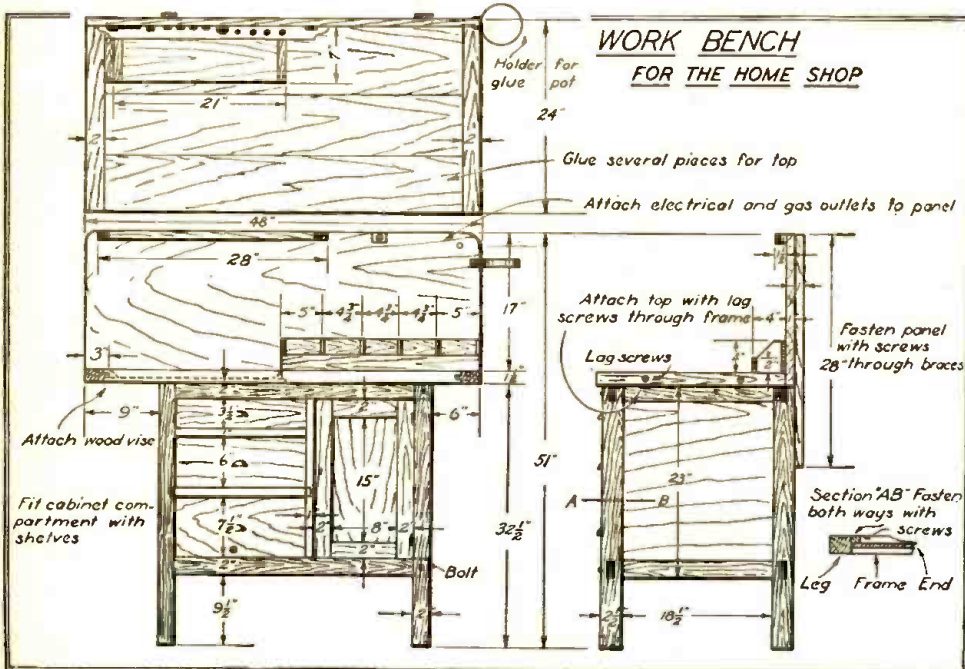

The complete detail of the different parts of the work-bench is included in this sketch, the plan view being at the top. The modifications to adapt it to radio service use are simple and at the option of its future user.

Causes and Cure of Radio Interference

(Part III)

A further consideration of the electrical "strays" that cause poor reception, and of the methods required to discover their points of origin and combat them

By F. R. BRISTOW

Supervisor, Home Study Division, R. C. A. Institutes, Inc.

TROUBLES rising from the normal operation of domestic and other electrical appliances were considered last month. We shall close this series with a brief consideration of the troubles arising from power-distribution systems.

A few of the sources of inductive interference caused by trolley, elevated, and subway traction lines are: Sparking commutators; trolley and rail contacts; sparking of motors driving the air compressors on the cars; sparking at the contactors of the controllers; faulty line insulators; and poor rail bonding. A longer list could be written; but this is sufficient to indicate some of the possible sources.

It is often found that disturbances from any one of the above causes may create little or no interference close to their source; but the high-frequency currents generated in such cases travel by means of the rails or power lines and thus may cause interference in locations at considerable distances from the source rather than locally. In some localities, trolley and feeder wires often run parallel with telephone, telegraph, or light wires; and the high-frequency impulses originating in these lines are transferred by induction to the other lines paralleling them. In this way, the interference which started in one line may extend for great distances in other lines. It is conditions of this kind that make radio interference sometimes a "will-o'-the-wisp" and almost impossible to trace to its source.

Instances have been known where interference has been set up from spark dis-

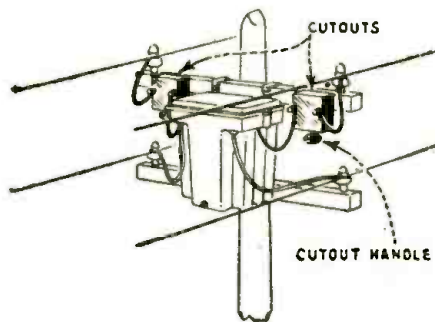

Fig. 23

"Static" noises may be caused by imperfect contacts within a power transformer, usually at the points indicated.

charges occurring through the oil film between the shaft and bearings of rotary converters. This trouble was overcome either by insulating the base, or by making an electrical connection between the base and the shaft through a wiping contact. Examples of this kind are interesting because they serve to show unlikely places that may be sources of radio interference.

Street Lighting

Defective lamp sockets, grounds caused by the power-supply lines coming into contact with the branches of trees, especially in wet weather, and loose splices, are all causes of radio interference.

A loose primary cut-out on a transformer will often cause trouble. Fig. 23 shows the general position of the cut-out in an actual installation. If a good tight contact is not made at the cut-out, slight vibrations of the pole will cause minute interruptions in the current supply, and result in surges being radiated to great distances either side of the defective unit. All wire lines parallel or close to the line, in which the faulty part is connected, will pick up this disturbance by induction and propagate it for miles.

If arcing occurs between a transformer case and the primary leads of a high-potential line, it will produce a harsh buzzing sound from the loud speaker. This noise often becomes so loud that broadcast reception is blotted out for hours.

High-Potential Systems

High-voltage transmission lines contribute to radio interference problems, chiefly because of leaky condensers, and also because of heavy surges of current set up by some faulty unit. This disturbing energy is transferred by induction to other parallel systems, causing interference perhaps twenty miles from the source.

A "horn-gap lightning arrester," of the

type shown in Fig. 24, will discharge during snow and sleet storms; thus causing heavy clicking and snapping which can be heard in the reproducer.

From this discussion it should be apparent that the elimination of radio interference caused by power and traction lines is to be undertaken only by men qualified and equipped to work on these systems.

Location of Trouble

We now come to the work of definitely locating the source of radio interference. In this work the assistance of broadcast listeners is often of great help in quickly locating the trouble.

For example, owners of sets who are experiencing excessive interference are often requested by the power companies in their locality to keep a log of (a) the time the interference begins; (b) its characteristic sound; (c) the time it ceases, and; (d) whether it comes in with certain regularity, or only now and again. Information of this nature is very helpful in making a preliminary study of the situation before actual field work is begun. In a measure, it aids the men seeking the trouble; for it enables them to determine whether they will have to attack the problem from the standpoint of a fixed source, from which the interference is being propagated, or consider it one caused by transient phenomena.

After a study of the trouble has been made and it has been definitely determined that the interference is originating outside

(Continued on page 469)

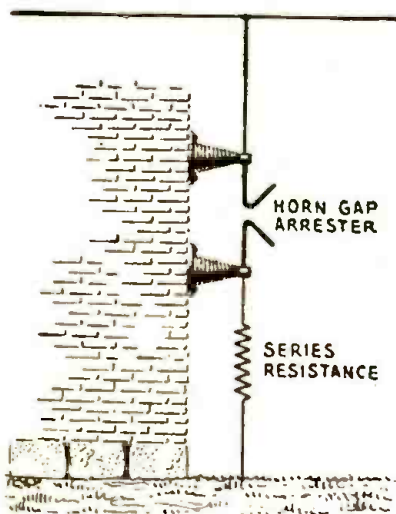

Fig. 24

The resistor in series between the horn-gap arrester and ground damps the natural oscillation of the circuit and reduces interference caused by atmospheric sparking across the gap.

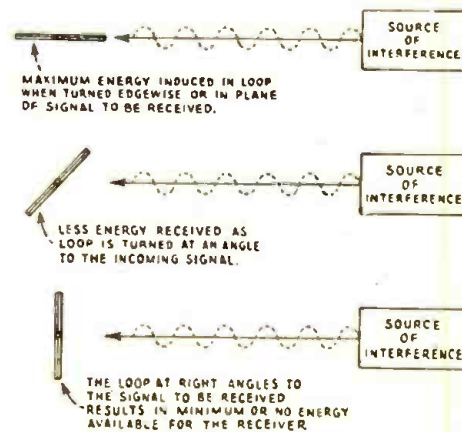

Fig. 26

While the loop, as shown, indicates the direction of the conductor which acts as an aerial radiating "strays," the apparatus originating the trouble is often a long ways from the apparent "source."

SPARTON "EQUASONNE" MODELS 931 AND 301 D.C.

Although grounds are shown in the schematic circuit of this set, no ground should be connected to this set. The reason is that one side of the D.C. line is grounded at the power house; consequently, if, for example, with the line-plug connections reversed the set should be connected to an external ground in any manner a short-circuit would result. In some D.C. sets fixed condensers will be found in both ground and antenna leads; in this receiver accidental grounding of the antenna (which usually results, when the lead-in insulation of a poorly installed aerial is rubbed, through permitting the lead to touch metal on the building) is prevented by the antenna condenser shown. An additional safety factor in the D.C. "Equasonne" is a 3-amp. fuse in the negative side of the line.

All tuning is obtained before the input of V1, a band-selector circuit being used to secure the desired selectivity. The signal is then amplified successively by V1, V2, V3, V4 and V5 (V6 is the "power" detector); the signal transfer being made through "aperiolic" (broadly-resonant) R.F. transformers. In series with a special R.F. coil arrangement in the plate circuit of V1 is a 2,800-ohm resistor, shunted by a fixed condenser of very small capacity.

The bank of three 15-ohm resistors in series with the reproducer's field coil limits the current consumption to approximately the correct amount; more accurate adjustment for high- or low-line supply is obtained through the 7-ohm resistor which is controlled by the shorting switch marked "Hi-Lo." ("Lo." below 115 volts; "Hi," 115-125 volts.) It has been found that the "110-volt" D.C. supply in some districts may rise to a value of 135 volts; and the remedy in this case is to add to the three-resistor bank a fourth resistor, also of 15 ohms.

The Service Man is recommended to check first the 15-ohm resistors in the 45-ohm bank. There is no other outstanding point for test. In the event of trouble, in this set; the dynamic reproducer requires usually no attention.

The volume control in this receiver has a resistance of 50,000 ohms.

A few cautions must be observed with regard to the filament circuit of this receiver. If the pilot light should burn out, replace it at once;

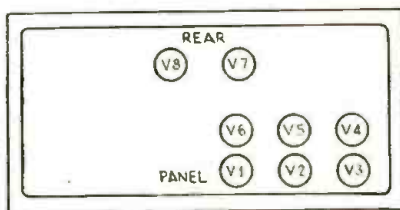

Tube arrangement of the "Equasonne" D.C. models.

this will bring back to normal the increased voltage across the filaments of the Type-182 (Sparks-Withington Co's.) power tubes V7-V8 (equivalent to the standard 71A). The dial light, with a 63-ohm resistor in series, is shunted across the filaments of the R.F. amplifiers and the power detector V6. Therefore, if the filament of one of the type "484" tubes should burn out, V9 will act as a fuse and also burn out; this should be to the Service Man an indication of the trouble. For this reason, too, tubes should be removed from their sockets only when the set is disconnected from the line, to prevent burning out V9. (If the heater [filament] of one of the 484s should burn out, the remaining tubes in the series will not light until the circuit is completed through a replacement tube or an equivalent resistor.)

As the Sparton tubes carry a 90-day guarantee, the Service Man should acquaint himself with the limitations of this guarantee. The specifications set by the manufacturer for tubes subject to replacement and bearing the proper sticker, dated, are as follows: low amplification; low emission; loose bases; defective welds; unsoldered terminals; gassy; open heaters; one element shorted to another; loose pins; low mutual conductance; no plate current; loose elements; open filament. Tubes having loose tops; broken glass; broken stems; broken bases, or dated outside the time limit cannot be replaced.

An external "C" battery supplies the bias for the power tubes.

V9 may be a 3.8-volt Mazda 13, type G3.

The current in the filament-heater-resistor

circuit is approximately 1.5 amperes under correct conditions. All continuity tests of the apparatus should be made with the set off the line.

Absence of plate voltage on the detector V6 may be due to: lack of line voltage; an open R.F. choke CH; open push-pull-input A.F. transformer primary; or a ground in the R.F. amplifier.

Operating voltages for this set are as follows:

Plate voltage, V7 and V8, 115; V6 (volume "on"), 100-108; V1, V2, V3, V4 and V5, (volume "on"), 112.

Grid voltage, V1, V2, V3, V4 and V5 (volume "on"), 2 to 3; V6, 8 to 10; V7 and V8, 22 1/2.

Filament voltage, V1, V2, V3, V4, V5 and V6, (across the six tubes in series) 18; V7 and V8 (across the two tubes in parallel), 4 to 4.5.

For reference, the characteristics of Sparton tubes are given in the accompanying table; in which SN is the Sparton tube-type designation; FA, filament volts; EA, filament amps.; GV, grid volts; PV, plate volts; PMa, plate milli-amps.; PR, plate resistance; Mu, amplification factor.

SN	FV	FA	GV	PV	PMa	PR	Mu
484	3.0	1.25	3	90	6.0	16,000	12.5
585	7.5	1.25	45	250	55.0	2,000	3.8
182B	5.0	1.25	29	200	18.0	2,400	5.0
181	3.0	1.40	29	200	12.0	1,500	3.7
401	3.0	1.40	3	96	6.0	7,000	9.5
226	1.5	1.95	3	90	6.0	7,000	8.2
227	2.5	1.75	9	135	6.0	9,000	9.0
686	3.0	1.25	3	90	2,000	3.8
182	5.0	0.90	45	200	18.0	2,000	5.0

The Sparton tubes numbered 171, 373, and 201A have been discontinued. The 401 is a "side-heater" tube similar to the Kellogg tube of the same characteristics. The 585 has a wire mesh plate, the 686, also a high-power tube, has a solid plate. The 182 has a slightly larger output than the standard 71A. The 484 is a hi-mu tube with a 3-volt filament. The 182B is a special 5-volt tube with slightly higher output than the standard 45. Type 280 and 281 tubes are similar to the standard '80 and 81.

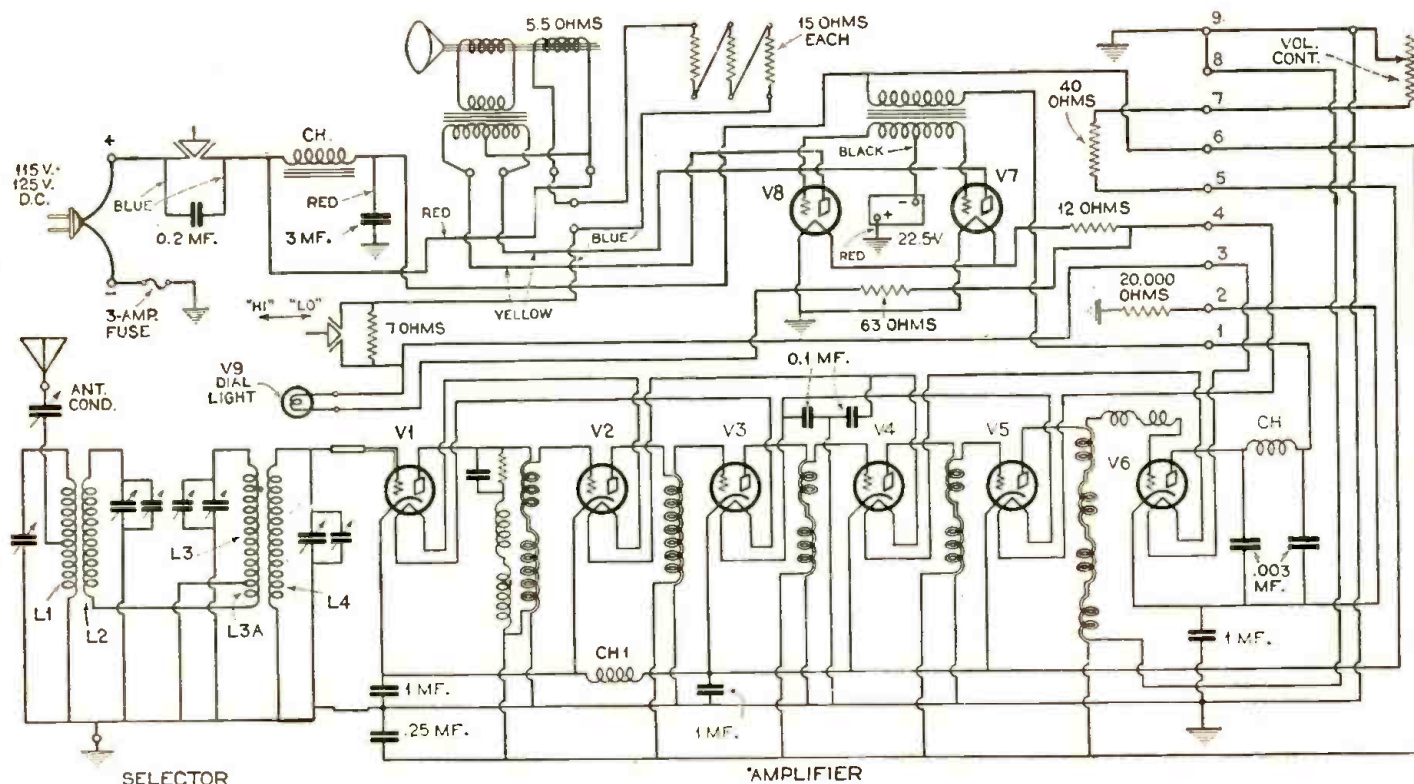

PHILCO 87

This receiver is of the neutralized, tuned-radio-frequency type. For local reception, in certain localities, good results will be obtained when the light-line is used as the antenna. To do this, connect a jumper from "Loc." to "Ant.," coupling to the line is then obtained through the series condenser C21 in the filter block. The receiver is shipped with this connection already made.

High selectivity in this receiver has been achieved by the use of four tuned stages, ganged, with compensating condensers for balancing the tuning of each stage, in addition to the panel-mounted compensating condenser, VC, which carries a spring contact. This last control resonates the antenna stage of R.F.; when this condenser is rotated counter-clockwise the grid of the first tube V1 is disconnected from the input circuit and grounded. This is the short-range position, used for strong signals. For weak signals the knob should be rotated clockwise, to reconnect the grid of V1 to the input circuit. Further adjustment to the right allows finer tuning of the antenna circuit.

When using the light socket as an antenna it is advisable to reverse the light-socket plug to determine the best connection for maximum signal strength and minimum hum.

The tubes used in this receiver are: four '26s, V1, V2, V3, V5; one '27, V4; two '45s, V6, V7; one '80, V8.

A good ground connection should always be used with the "Model 87" receiver, which uses the Hazeltine neutralizing system.

The tuning scale used on this set is numbered from 55 to 150. The numbers represent the 96 authorized broadcast channels, and by adding a cipher after each, give the kilocycles. For example, 85 on the scale represents channel number 85 and a frequency of 850 kilocycles.

Lack of sufficient voltage on the R.F. tubes may be due to a grounded hum adjuster R6.

The "Loc." connection is convenient for testing the general efficiency of the outside antenna. If signals are not heard with the outside antenna connected, but good reception is obtained when the "Loc." terminal is connected to "Ant.," the outside antenna system should be checked.

The efficiency of the ground connection may be checked by removing the ground connection while weak signals are being received. There should be a reduction of the volume if the ground connection is good; no reduction denoting a poor ground. (This reduction in volume will not be noticed if the test is made on strong signals.)

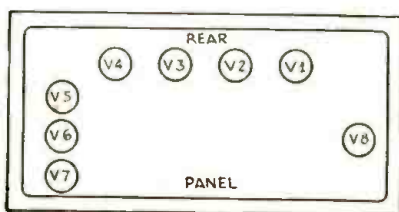

Tube layout of the Philco "Model 87."

If the neutralizing condensers (C1, C2, C3) should short-circuit the plate voltage of the R.F. tubes will be increased, in addition to the circuit's "going dead" so far as signal strength is concerned. A grounded neutralizing condenser will result in very weak signals.

If the circuit tunes broadly, after care has been taken to balance the tuning of each stage, one of the R.F. transformers may be at fault. These are readily replaceable and interchangeable; the constants all being standardized.

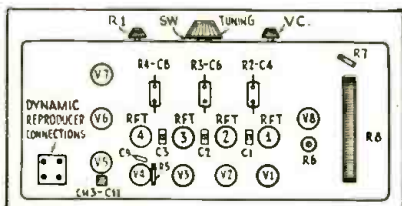

Under-chassis arrangement of the "87." In the open or local position of VC, the neutralizing condenser C1 becomes a coupler to V2, which is then the first R.F. tube.

A caution is issued by the manufacturer with regard to the tuning-condenser gang. If it has been positively determined that the trouble lies in the alignment of the condenser plates, remove the entire condenser and return it for adjustment. The screws holding the stator plates of the tuning condenser in place, and those holding the rotor bearings, should never be loosened. The compensating condensers C5, C7 and C10 may be adjusted with a wrench to equalize the tuned circuits. Replacement R.F. transformers of standard values are separately obtainable.

If trouble has been localized to the dynamic reproducer, a check with a voltmeter across

the field coil should show approximately 135 volts drop.

With a line-voltage of 125, the "Model 87" draws 95 watts from the power line, and the correct set voltages are as follows:

Three R.F., and the first A.F. stages, filaments 1.5 (winding A); plate 90; grid bias 6. R2, R3, R4 are low in resistance and do not reduce plate voltage perceptibly.

Detector heater 2.5 (winding B); plate 30; grid bias 0.

Second A.F. (and pilot lamp) filaments 2.5 (winding C); plate 245; grid bias 45.

Rectifier filament, 5 volts; across secondary 700.

The code used in wiring the receiver is:

- | | |
|---|--|
| Leads from | Colors |
| A.C. Supply | Green rubber covered |
| A.C. Supply | Black rubber covered |
| A.C. Supply to C21 | Blue, white tracer |
| "Loc." post to C21 | Black |
| Winding A ('26 filaments) | White, black tracer |
| Winding A ('26 filaments) | Black, white tracer |
| Winding B ('27 heater) | Yellow, green tracer |
| Winding B ('27 heater) | Yellow, plain |
| Winding C ('45 filaments) | Green, yellow tracer |
| Winding C ('45 filaments) | Green, plain |
| Winding C center tap | Green, black tracer |
| Rectifier winding center tap | Yellow, rubber covered |
| Ch 1 (high-voltage side) | White |
| Ch 1 (low-voltage side) | Push-Pull plate lead and Field Coil, high side |
| Ch 2 (high-voltage side) | Black, yellow tracer |
| Ch 2 (low-voltage side) | Blue, plain |
| Ch 2 (low-voltage side) | and amplifier plate leads |
| R7 (low-voltage side) | Yellow, green tracer |
| and "B+" on A.F. transformer (detector plate) | Yellow. |

Values of parts are given as follows: R1, 10,000 ohms; R6, 6 ohms. C4, C6, C8 (units include R2, R3, R4), each 0.1-mf.; C11, 0.01-mf.; C19, C20, 0.5-mf. The following are included in the filter block: C12, 0.1-mf.; C13, C15, 1-mf.; C14, C16, C18, 2-mf.; C17, C21, 0.15-mf. R7, 70,000 ohms; R8, 4,582 ohms tapped at 157, 640 and 3,785 ohms.

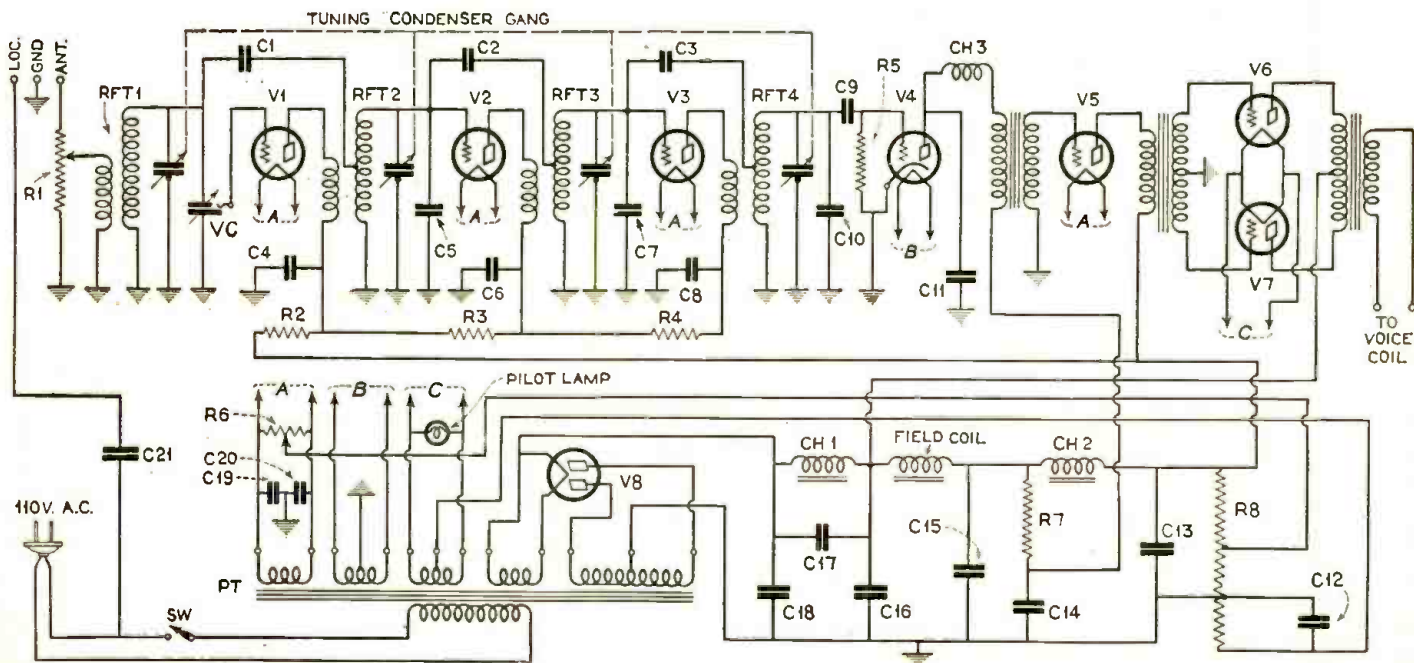

The Service Man's Open Forum

"THE SPECIALIST, THE MAN OF EMINENCE"

WHAT radio needs, and must have if we expect it to progress, is careful selection of radio dealers and Service Men.

The main trouble with the majority of radio dealers is that they either sell too many lines of radio, change the makes they are selling too often, or both.

The time has now arrived when radio dealers, if they expect to succeed, must sell not over two lines of radios, and give service on these. No Service Man, no matter how good he is, can be an expert on all makes of radios. The reason is that practically every radio circuit is just enough different so that, if a radiobrician tries to be an expert on all makes, he is usually an expert on none.

However, I do not mean that a Service Man should work on only one or two lines of radio; what I do mean is that he should specialize in one or two lines. If he does this, I sincerely believe it would be better for all concerned.

I have been servicing receivers, of practically every popular make, for the last four years, and I am considered an expert along this line. However, I specialize on only a few makes, and I am quite sure that the greater part of my success is due to this fact.

In the last year I have received several complimentary letters from manufacturers who stated that patrons who bought receivers from their dealers were greatly pleased with my work; and, on two occasions, the manufacturers forwarded service manuals to me. This is what can be called real cooperation on their part; because these were forwarded without my asking for them.

Therefore, my advice to the Service Man is to specialize in the repair of one or two makes, and to understand them thoroughly.

JAMES CLAVE ELLIOTT,

Roseaire Garage, Claysville, Pa.

(What have our other readers, including the dealers, to say?—*Editor.*)

THEORY OR PRACTICE

IT is with some amusement, a good deal of deliberation and some regrets that I read a good many opinions on what radio needs. I would like to express some of my own ideas.

Service with us has been a hobby, a side line, and finally something that just naturally grew to large proportions.

In the first place, I don't think examinations will do any good except, probably, to eliminate some good mechanics and increase the field of "gyp" artists. There are a few things which can be figured out with a pencil, and many which a man learns by actual experience.

Next, we need a little more honesty on the part of the dealer and salesman. During my vacation (two weeks) I sat around and observed what not to do to stay in business. There is no excuse for a service department being maintained as a necessary evil; it should be self-supporting.

As to test kits, every good mechanic has his own ideas as to the tools he wishes to

OPPORTUNITIES

The "Opportunities" column of this month's issue of RADIO-CRAFT will be found on page 479 of this issue. The Service Man who desires to take advantage of this feature may do so without cost, as explained there.

use, and makes his own deduction from the results obtained in his own manner. Since he is the owner, he dislikes the idea of being told what he should or should not use.

The independent Service Man will always be with us and, as for myself, I'll stay that way and take any thing that comes my way; and take my chances on being as close to up to date as the next one.

D. K. SKEELS, ALICE,
1752 Pilgrim Road,
Toledo, Ohio.

ADVERTISING FOR SERVICE WORK

AS one of the great multitude of service men throughout the country, I would like to tell others through RADIO-CRAFT how I stirred up more work in repairing and servicing radio sets, by running this advertisement in a local daily newspaper—until it became impossible for me to handle it all.

WANTED

Radio Servicing and Repairing
All Makes of Radios

Experience combined with manufacturers' data, takes the guesswork out of all our repairing.

Looking over my ad one night, I got to thinking: why is it that I have to look through a pile of books and magazines to find the desired circuit and information, when one volume of these service sheets would save the Service Man a lot of gray hairs, when he starts to repair a receiver?

A volume of nothing but service sheets, of nearly all the standard makes of radio, would easily sell to any Service Man.

It is an honest-to-goodness job for a Service Man to get service sheets out of a manufacturer. Maybe he will send you one if he got out of bed on the right side. The manufacturers are so busy with their orders during the season they do not pay any attention to a Service Man unless he happens to be a dealer in their locality.

On the other hand, magazines publish from three to four sheets a month on different types of sets; in twelve months, say, forty-eight. Radio manufacturers in Chicago and Cincinnati alone make more than twice that number of different models.

The manufacturers with their everlasting changes in sets, speakers, etc., keep the Service Man working both day and night to figure out all their little contraptions. If he had a volume of their service sheets he could turn to the desired information, instead of looking through a pile of books and magazines scattered here and there, and give the kind of service the public wants.

JAMES C. AMORY,
252 Hanover St., Hamilton, Ohio.

THE CUSTOMER SPEAKS

CONGRATULATIONS on your editorial, "Frenzied Radio," in your February issue. That is one fine New Year's gift to the radio listener, the Service Man and, also, to the manufacturers of radio sets—if they have horse sense enough to profit by the warning. I am certainly gratified to see some one connected with the radio industry shed light, at last, on an utterly rotten condition which is and has been detrimental to all concerned.

I am operating a fairly late-model battery set, with "B" power pack and "A" battery, and I might state that my first set was purchased in 1924 when radio was young. I now feel the urge to place a modern A.C. set in my home; but I will not do so until I can assure myself that intelligent service is obtainable when needed; and, as you well know, there is only a remote possibility that such service can be had under the present attitude of the manufacturers toward Service Men.

I believe that the average Service Man is honest in his endeavor to fix his customer's receiver in a satisfactory manner; but it is evident that the manufacturer does not desire the set repaired—with the false notion that such an attitude will result in further sales—and for this reason refuses to furnish proper circuit and other data.

My reference above covers the Service Man strictly—and not the "set slaughterer" who is sent forth by some retailers, like a snake in the grass, with probable instructions to place the unhappy customer's receiver in such a condition that he will be glad to trade it in.

I am keenly interested in the progress of radio, and am perfectly willing to expend my share toward the upkeep of the industry if I can feel that I am likely to get a square deal. Until then, my dollars stay at home, and the old battery set will continue to work overtime as in the past.

Hoping that you will keep up the good work and not let the "big boys" scare you out, I am,

Sincerely yours,
E. B. CLARK,
724 East 41 Street,
Baltimore, Maryland.

(We print the above letter from a radio fan who is not a Service Man, as only one, yet a typical, expression of the feeling of a long-suffering public which refuses to be "kidded" any further by the radio industry.—*Editor.*)

THOSE CURRENT SURGES

WITH reference to Mr. C. O. Merwin's article on protecting A.F. amplifiers in the December issue, I have devoted considerable time to this subject. No doubt keeping the plate current out of the transformers is a very good idea; but, with regards to soldered joints, I take issue with him if the rosin flux is used. It is true that a galvanic action results when different metals are joined; however, this action is so slow I doubt if it would have any weakening effect on new transformers.

If Mr. Merwin cares to prove where and
(Continued on page 478)

Men Who Made Radio—Guglielmo Marconi

THE SIXTH OF A SERIES

THERE is many a name which epitomizes an entire art in the minds of its hearers; because its bearer had the genius and the timeliness to make the successful step which reduced a plausible theory to successful, efficient practice. The name of Watt is almost synonymous with steam engineering; that of Morse with land-line telegraphy; that of Edison with electric lighting; and that of Marconi with radio communication. When Marconi came upon the scene, the discoveries of science had shaped the theory of radio; only one thing remained—to make it work. Marconi did so; to extend the old simile a step further, he not only made the egg stand upon its end, but he hatched it.

Guglielmo (William) Marconi was born in Bologna, Italy, April 25, 1874. His scientific education was acquired at the centuries-old university of his native city, where his mind was intrigued especially by the possibilities latent in the mysterious electric waves which Maxwell had predicted and Hertz had demonstrated, a few years before. The time was ripe for a new, epoch-making invention. The concept of universal communication through the ether was obvious to many scientific men; as Sir William Crookes had put the matter in 1892, "all the requisites needed to bring it within the



grasp of daily life are well within the possibilities of discovery. Even now, telegraphing without wires is possible within a restricted radius of a few hundred yards."

So much, Marconi had proved for himself in his university laboratory and during his vacations at home. Like Watt, Marconi beheld a giant crying for useful employment; and determined to make it his life's work to turn that "possibility" into an actuality. At the age of twenty-two, he landed in England, in the year 1896, to seek the associates necessary to the fulfillment of his plan.

In some respects, the young inventor was favored by fortune. English was to him a familiar tongue; for his mother was of Irish birth. He met with official encouragement in high circles, in place of the unintelligent conservatism which often stares frigidly at new ideas. He found a welcome from Sir William Preece, chief technician of the British telegraph and telephone system, who had himself experimented with the idea of "wireless" communication, and given a demonstration, although uneconomically.

Marconi's first demonstrations at the London general post office were encouragingly successful. Then followed experiments on Salisbury Plain, in southwestern England. By March of 1897, messages had been sent for four miles. In July of that year, with ample financial backing, he was enabled to organize the Wireless Telegraph and Signal

(Continued on page 469)

Attention: Radio Service Men

RADIO-CRAFT is compiling an international list of names of qualified service men throughout the United States and Canada, as well as in foreign countries.

This list, which RADIO-CRAFT is trying to make the most complete one in the world, will be a connecting link between the radio manufacturer and the radio service man.

RADIO-CRAFT is continuously being solicited by radio manufacturers for the names of competent service men; and it is for this purpose only that this list is being compiled. There is no charge for this service to either radio service men or radio manufacturers.

We are hereby asking every reader of RADIO-CRAFT who is a professional service man to fill out the blank printed on this page or (if he prefers not to cut the page of this magazine) to put the same information on his letterhead or that of his firm, and send it in to RADIO-CRAFT. The data thus obtained will be arranged in systematic form and will constitute an official list of radio service men, throughout the United States and foreign countries, available to radio manufacturers. This list makes possible increased cooperation for the benefit of the industry and all concerned in the betterment of the radio trade.

NATIONAL LIST OF SERVICE MEN.

c/o RADIO-CRAFT, 98 Park Place, New York, N. Y.

Please enter the undersigned in the files of your National List of Radio Service Men. My qualifications are as set forth below:

Name (please print)

Address .. (City) .. (State) ..

Firm Name and Address ..

(If in business for self, please so state)

Age .. Years' Experience in Radio Construction? ..

Years in Professional Servicing? ..

Have You Agency for Commercial Sets? .. (What Makes?) ..

What Tubes Do You Recommend? ..

Custom Builder .. (What Specialties?) ..

Study Courses Taken in Radio Work from Following Institutions ..

Specialized in Servicing Following Makes ..

What Testing Equipment Do You Own? ..

What Other Trades or Professions? ..

Educational and Other Qualifications? ..

Comments ..

(MARCH) .. (Signed) ..

Troubles in Radio Mass Production

A frank discussion of the problem confronting the manufacturer of popular radio receivers, and of the manner in which his troubles bob up in the Service Man's problems, also

By SYLVAN HARRIS

YES, there are troubles in radio—plenty of them. But so far as Mrs. Jones, who just received her latest umpty-dyne set for Christmas is concerned, radio troubles may just as well not exist. She has never heard of them and, even though she had done so, it would be difficult for her to conceive how there could be any troubles encountered in building radio receivers.

Why, all they have to do at the factory where they build them is to take a number of parts and fasten them together with screws (or eyelets, if she has ever heard of them except as components of women's wear).

Those of my readers who have had anything to do with the building of receivers certainly know better than this; and so especially do those who make it their business to service radio sets. But, even at that, it may seem strange that, in building radio receivers in large quantities, there is so much opportunity for the occurrence of troubles, which are not even suspected by those who build their own, or by those who make radio kits for the customer to assemble himself, or even by those who service a great many receivers.

The Service Man says: "I can thank my lucky stars that they do have a lot of trouble—because it is from this that I make my living—but, confidentially speaking, I don't understand it at all."

The Set Builder's Viewpoint

Let's look into the matter a little further. Why doesn't the Service Man, as a rule, or the parts-and-kit manufacturer, or the home set builder realize these difficulties? The answer cannot be given in a few words; but, among the principal reasons, we may cite the following:

In the first and perhaps the most important place, all these people happen to

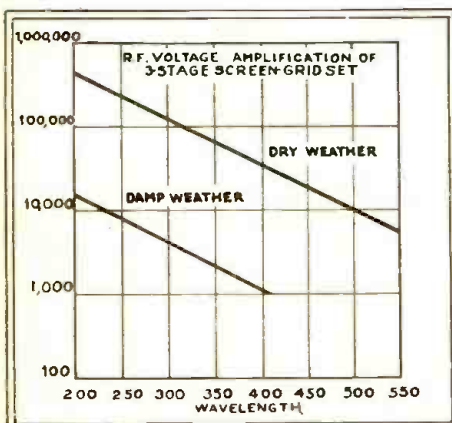

Fig. 1

This is an engineer's diagram on a scale showing that the measured sensitivity of a commercial receiver is twenty-five times as high in fair weather.

fall, in a general way, into the category of "custom-set builders." Take, for example, the man who builds his own set. After assembling and wiring it, he tries it out on the air, and finds it does not work as it should. Naturally, he first takes the blame on himself; he feels that he has made a mistake somewhere in the assembly or in the wiring of the set. Then he spends a lot of time looking for the trouble. Eventually, he finds and corrects it, and the set works wonderfully.

This is all very satisfactory when there is any actual break-down in the circuit, such as a burnt-out transformer winding. But what about the case where the set works very well for a while and then, all of a sudden, the operator finds that the sensi-

RADIO-CRAFT is pleased to welcome Mr. Sylvan Harris to our list of contributing radio authorities—and so, we are sure, will be our readers—because he is one of the most interesting writers in radio. Mr. Harris, formerly managing editor of RADIO NEWS, has been during the past four years engaged in design and production research with Stewart-Warner, Kolster, Fada and other manufacturers; and his technical contributions to the *Proceedings of the I. R. E.* have been frequent. It may well be imagined that Mr. Harris speaks with authority on the subject of factory production of sets.—*Editor.*

tivity is far below what it was last week? "Why," he says, "last week I could hear WXYZ all over the house, and today I can't get it at all."

Then, next week, he finds that things have returned to normalcy, and that he can not only hear that station again, but hear it now louder than ever.

No Allowances Made

Now, let us see what this condition may lead to in the case of a factory-built set. If Mrs. Brown went into a dealer's store to buy a certain set during the week when its sensitivity was low, she naturally would change her mind and say that this set was not as good as Mr. Black's, and that it was only by accident that the manufacturer of the latter set turned out a good one. So a sale is lost to the manufacturer.

Now, what could cause difficulties like this? This tale I am telling is characteristic of a great number of difficulties which arise, and the causes of these troubles are many—very many. And the ways in which they manifest themselves are as varied as the causes which produce them.

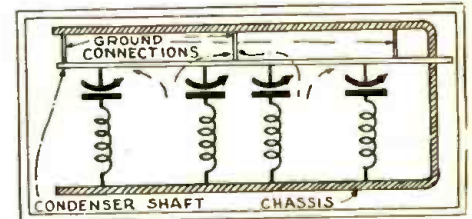

Fig. 2

The many grounds on a set chassis are not always low-resistant; special wire interconnections cost higher in labor.

Manufacturing Coils

For the first example, let us take the case described above. Economic reasons are forcing more and more manufacturers to use paper forms on which to wind their radio-frequency transformer coils. Paper forms are much less expensive than forms made of bakelite or other similar material. But, in using them, proper precautions must be taken in the matter of impregnating them against moisture. When this is done, it is found that paper forms are quite satisfactory for all practical purposes.

What precautions are necessary? It is not sufficient to merely coat the winding with a varnish or lacquer. This would actually imprison within the paper any moisture which might be there before the impregnation. The forms, after punching or drilling, should be well baked, in order to drive out all moisture, and then dipped, (not merely painted over) in lacquer or varnish. The varnish should then be dried, slowly, in an oven.

The form is then wound, after which it may again be dipped, or coated by hand. If silk-covered wire is used, instead of enamelled wire, for the secondary winding, there should be an additional heating process before applying the coating to the wire.

Now, many of you will say that this is not news. But it is surprising how much trouble has arisen from attempts to eliminate some of these steps in the process, in order to save labor or material costs, or both. And this problem seems to be more important in connection with screen-grid sets than in our previous models; since, in the former, the amplification (or sensitivity) is inversely proportional to the resistance of the tuned circuit.

In dry weather, untreated coils may have an R.F. resistance of, perhaps, 10 ohms; whereas, in humid weather, enough moisture may be absorbed to cause the resistance to rise to double or triple the original value. It is an easy matter, therefore, for the sensitivity of a three-stage receiver to drop down to one-tenth of what it ought to have, or even less than that. This has been proven, time and again, by baking an entire receiver in a drying oven and making measurements before and afterwards. The ef-

(Continued on page 471)

Obtaining Energy for a Dynamic Reproducer

A convenient method of using an auxiliary power unit to operate from the rectifier of a power pack and supply exciting current for the speaker's field coil

By LOUIS B. SKLAR

THE "dynamic" reproducer is generally considered best for reproducing speech and music. One of the outstanding features of this type of reproducer is its electromagnetic field, which is used instead of the permanent magnet employed in the "magnetic" type of speaker.

The direct current required to energize the field of a dynamic speaker can be obtained in five different ways: (1) A six-volt storage battery; (2) a low-voltage rectifier, similar to the trickle charger used for charging storage batteries; (3) the 110-volt D.C. house current; (4) using the field as a choke coil in the "B" unit; or (5) by building a small "B" unit which consists of a set-up transformer, a type '80 tube, and a condenser. In the last case, the field of the dynamic speaker, with the condenser, constitutes the filtering system.

The applications of methods one and three are limited and very little used. Method four can be used only by set manufacturers who can design their "B" eliminator to compensate for the voltage dropped in the filter system, on account of the high D.C. resistance of the field winding of the speaker.

No. 2 was and still is the one most commonly used for "dynamics" in existing electric sets; or any set—with or without "eliminators." This method is not entirely satisfactory; as the 60-cycle hum may become audible.

A Convenient Method

And so No. 5 has been lately adopted by reputable speaker manufacturers. This method produces current without any trace of hum for energizing the field windings of dynamic reproducers. The writer has de-

The ingenious device here shown permits the operation of an electrodynamic reproducer—without built-in current supply—from a receiver of any type which was designed for a magnetic speaker. It will doubtless suggest profitable possibilities to many Service Men.

Have you tried out some original ideas which have a commercial possibility of this kind? If so, let us hear about your success.—Editor.

vised a new method which produces the same results, but at a lower cost.

A glance at Fig. 1 will show how this is accomplished. You will observe that the whole thing consists of making the high-voltage side of the regular "B" unit transformer do a double duty; *i.e.*, it supplies energy to two rectifying tubes—one is the regular "B"-voltage rectifier, and the other a gaseous rectifier tube. The latter tube, with the condensers and choke, supplies the energy to the dynamic's field.

This does not, in any way, interfere with the operation of the "B" unit; for the current used to energize the speaker's field winding does not go through the resistance network of the voltage divider. The potential "dropped" will amount to about ten or fifteen volts, on the "maximum" tap of the eliminator, and a proportional amount on the low-voltage taps. This should not affect the operation of the radio set; as in many cases, especially when only a few tubes are used, the voltage of a good "B" pack is slightly higher than is required for the set.

The arrangement of Fig. 1 is for a "B" power unit, or an all-electric set, having a type '80 rectifier tube. The parts required for this plug-in adapter are as follows:

- Two standard 4-prong sockets.
- Two 2-mf. condensers.
- Two 0.1-mf. condensers.
- One gaseous-rectifier ("Raytheon") tube.
- One bell-ringing transformer, 110-volt G.E. type.
- One 5-wire cable, with a 4-contact-point plug.
- Box, binding posts, etc.

Using a Gaseous-Rectifier

The same scheme can be used on a "B" unit having already a gaseous-type rectifier, with the modifications illustrated in Fig. 2. Here you will see the secondary of the transformer supplying two gaseous-type rectifying tubes. The parts required for this design are as follows:

- Two standard 4-prong sockets.
- Two 2-mf. condensers.
- One Raytheon-type rectifier tube.

One bell-ringing transformer, 110-volt G.E. type.

One 4-wire cable with a 4-contact-point plug (the plug can be made from an old radio tube base).

Box, binding posts, etc.

In either case, the adapter will supply the high-voltage D.C. field of a dynamic speaker with about 150 volts. If there is no hum in the radio set itself, there will be absolutely no hum heard in the speaker; even when your ear is at a distance three inches from it.

The size of box required for housing the equipment is very small. It takes up less room than the step-down transformer and rectifier required for the low-voltage type A.C. speaker.

The assembly and wiring is very simple, as there are very few parts.

When the adapter is completed, all you have to do is take out the rectifier from the "B" unit and put in the plug from the adapter in its place. The tube from the unit will go to the socket in the adapter provided for it. Any radio fan who likes the reproduction of dynamic speakers, minus the hum, will find that this adapter in conjunction with a D.C.-type (high-resistance field) dynamic speaker—and, of course, a good radio set—will meet his approval.

In conclusion, the writer wishes to add for the benefit of many radio fans that the D.C.-type speaker, because of its simplicity of construction, is about six to ten dollars cheaper than the A.C. type. It will therefore be seen that the difference in the cost of the two speakers will more than cover the cost of the parts necessary to build the adapter.

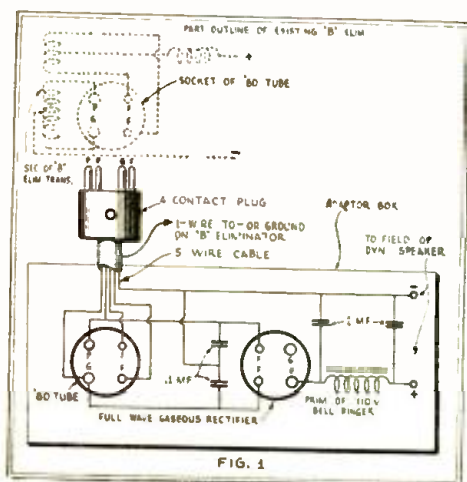

The arrangement of the field-coil's supply unit for plugging into the socket of the usual '80 type rectifier. The set's rectifier tube remains in its normal circuit, electrically; the reproducer takes current from a "Raytheon BH."

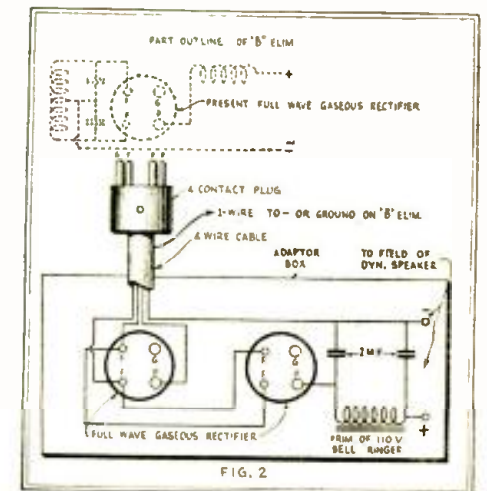

If the power pack of the receiver employs a full-wave, gaseous tube rectifier, the circuit of Fig. 1 is modified in this manner. In this case, the 0.1-mf. "buffer condensers" of the pack are utilized.

Servicing Automobile Radio Installations

(Part II)

In the preceding issue of RADIO-CRAFT, Mr. Sheedy described the earlier model of the "Transitone" automobile radio set. Here we have the latest type, with servicing hints.

By M. J. SHEEDY

SERVICING radio equipment in automobiles may be properly divided into two parts; first, the receiver and its accessory equipment; second, the method used to eliminate the disturbance caused by the electrical system in the car.

The Service Man must bear in mind that the operating conditions of radio equipment in an automobile are entirely different from those encountered in the home. For example, a receiver is installed in the owner's home, and reception in that particular locality is found to be poor. There are various measures that can be taken to offset this; such as lengthening the antenna or relocating it, or making additional ground connections. With the modern A.C.-operated sets in use, today, with four and five stages of radio-frequency amplification and high audio output, there is always a certain surplus of power which can be used to build up a weak signal. None of these are available in an automobile installation.

The automobile will, in the course of a few hours' run, encounter receiving conditions that may range all the way down the scale from perfection to zero. The problem, then, is to have a set efficient enough to hold the signal under these varying conditions.

Because the available antenna space is confined to the physical dimensions of the car top, we cannot, very well, increase the size of our antenna. The additional inductance and capacity would only overload the circuit, without giving any additional pick-up. In place of a ground, we must utilize the metal chassis of the car as a counterpoise. The plate current, being drawn from dry-cell batteries, must be conserved. Space again enters the question, limiting the size and number of batteries that may be used. This leaves the whole burden of assuring reception, under all varying conditions, on the receiver itself. The instrument must also be small and compact, in order to be adaptable for installation in any make of car.

In the first part of this article, which appeared in the February issue of RADIO-CRAFT, the model "TR.106" Transitone re-

ceiver was described and illustrated. Several thousand of these receivers are already in operation. The circuit is exceedingly simple, and the layout makes trouble shooting a simple matter; since voltage readings may be taken at any point of the circuit, and all wiring is readily accessible for inspection.

Care must be taken, in servicing this receiver, that the interior wiring is not disturbed. After assembling, all ganged circuits

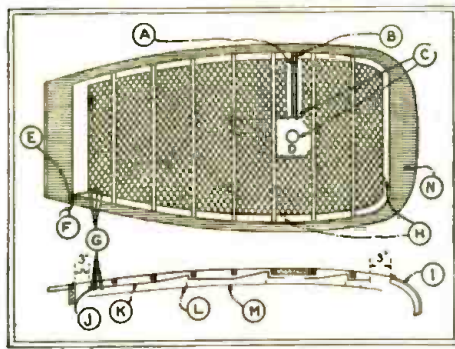

Fig. 3

A wire-mesh aerial K is used in sedans; the dome light D and its wires B must be shielded and spaced three inches from aerial, as at C. The lead-in F is connected at several points G, as shown in cross-section J. L, listing cloth, M, lining.

have been balanced at the factory within very narrow limits; and a slight change in the positions of the R.F. circuit wires might be sufficient to shift the resonance point of a stage and lower the over-all efficiency.

New Single-Control Model

A receiver known as Model "NR.109" has recently been developed by the Automobile Radio Corporation, to meet the demand for a single-control set. The complete receiver consists of two units; one contains the R.F. amplifiers, while the audio section is built into the second container. (These units are known as models "NR.107" and "NR.108," respectively). This model is used on all Chrysler cars which are radio-equipped at the factory. As several thousand cars are about to be equipped with this model, the following data will be of help to the Service Man.

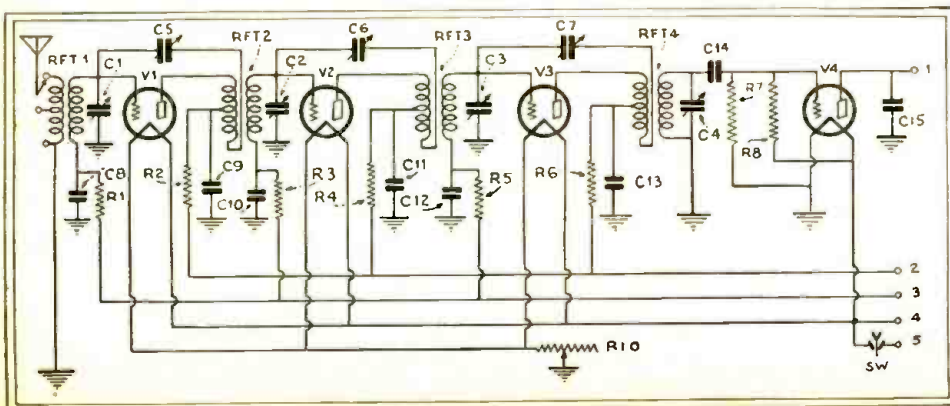

The set is turned on by means of a key operating a switch, which is usually located at the right of the tuning control, and is very similar in appearance to an ignition switch; a quarter turn to the right turns on the set. When the set is not being used, the key should be removed, thus preventing tampering.

The tuning is done by merely rotating the one dial through 180 degrees, or half a revolution, to cover the entire wavelength range of the receiver.

The volume control, a knurled knob in the center of the tuning dial, operates independently of the dial. Turning in a clockwise direction increases volume and counter-clockwise decreases volume.

General Test Data

If there is no signal or click from loud speaker when switch key is turned on and off, remove knurled knob holding cover of either box in place, and remove one cover. If tubes fail to light examine "A" battery connection. This is a wire leading from "Hot" or ungrounded side of starting battery to "B" battery compartment and connecting with "B" wire of set cable.

If "A" battery wire is intact and making good contact, and tubes still fail to light, examine plug connections on both set boxes and see that these are pushed together all the way. Examine key switch and be sure that there is a wire connected to each of the two terminals on rear of same.

If any one tube in the receiver does not light, replace with a tube of the same type as marked on the base of tube. The proper location of the tubes may be checked by referring to diagram.

If tubes light, but there is no click from the speaker, examine connections to "B" and "C" batteries in battery compartment. If all connections are in place corresponding with diagram (Fig. 1) test each battery with a voltmeter while the switch of set is turned on. When "B" batteries fall below 38-volts they should be replaced.

If batteries are good and all connections tight, and still there is no click from speaker, examine speaker connection to audio fre-

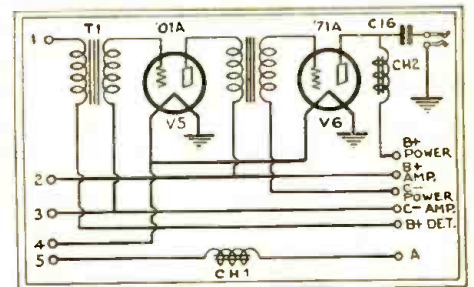

Fig. 2

"Model NR. 107" tuning unit, left; "Model NR. 108" amplifier above. Either R7 or R8, or both, may be used. Observe resistance-capacity filters in grid and plate leads. Part values are not given.

quency unit. This is made by means of a plug inserted into a jack in the side of the audio or smaller box. The speaker may be checked by plugging another speaker into this jack, in place of the regular car speaker. If the external speaker functions, the trouble lies in the car speaker or its connecting wires.

The 71-A type tube must be in the proper socket in the audio or smaller box. If a tube of another type is placed in this socket, the receiver will not function.

If the set operates, but stations received are weak, test "B" batteries with set turned on. Check "C+" battery connection. If the negative side of starting battery is grounded to frame, the "C+" must be connected together with the "A-B" lead from starting battery. Examine and test tubes to see if all are of proper type and of good characteristics.

The tuned circuits in the larger (R.F.) amplifier may be out of balance. This rarely

If the noise is a continuous crackle or roar which is loudest on the lower wavelengths (that is, with the stem of the tuning dial to the right) it is probably caused by local electrical disturbances, such as electric motors, power lines, etc. Driving to a location away from overhead wires should cause this interference to disappear. If the noise is noticeable only at night, when the car lights are lit, it may be caused by a loose bulb or dirty contact in a socket.

If the noise persists, even when the volume control is turned completely off, it may be caused by either a loose or dirty plug connection in the cables, a tube with dirty contact prongs, or a noisy battery.

The batteries may be tested for noise by connecting the terminals of a pair of telephones across each battery and listening for any crackling or hissing. Any noisy battery should be replaced. Care should also be taken to see that no moisture enters the battery compartment.

If there is noise or crackling, heard only when the car is being driven, but which disappears when the car is motionless, it is probably caused by dirty tube contacts. It is a good plan to remove each tube and clean the ends of the contact prongs with fine sandpaper. The surfaces of the tube-socket contact springs may also be cleaned this way.

Two types of antenna are used in Transitone installations. In sedan models a copper mesh is used; for touring, roadster models and all cars with folding tops, a very efficient antenna of flexible construction has been developed. (See Figs. 3 and 4.)

The plate and grid batteries are placed in a waterproof metal box, which is generally suspended through the floor boards in the rear of the car. In coupé and roadster models, the batteries can be reached by raising the back deck of the car.

The Car's Ignition System

An explanation of the action of the ignition coil will be of help in understanding the system.

In order to operate the high-tension coil we must use some method of interrupting the continuous direct current supplied by the storage battery. This is done by the action of the breaker points in the primary circuit of the car. When the breaker points

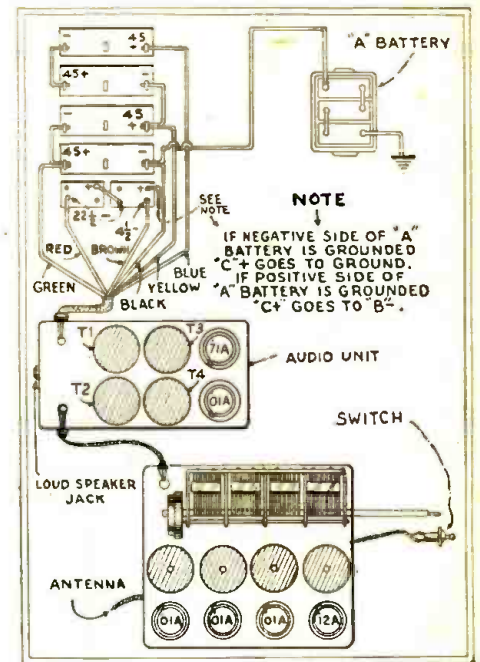

Fig. 1
Installation of the Model "NR-109" Transitone, employing the circuit of Fig. 2. Voltages have been increased and a 71A power tube introduced.

original primary impulse, but slightly out of phase with it, must be filtered. The placing of a by-pass condenser across the battery side of the coil and using the impedance of the primary winding as a choke makes an ideal filter for this purpose.

Applying the same law again we find it is important to keep all high tension wires and the lead between the breaker points and the primary side of the coil away from other wires of the system. The high tension conductors and other wires carrying this interrupted current create a rapidly changing magnetic field around them. Any wires of the lighting system coming within range of this field will carry the induced current back to all parts of the system. It can be readily seen how the antenna could pick up this induced voltage from the dome light and the wiring system behind the instrument board. It is quite obvious that all wires in the ignition system must be isolated.

Another source of disturbance is the generator. This is very easily remedied by plac-

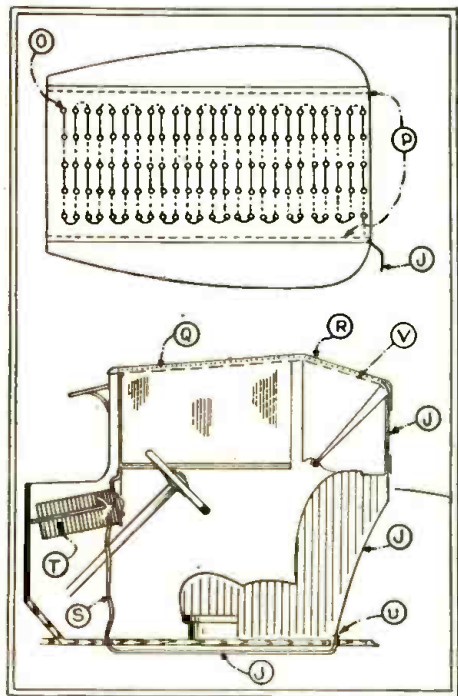

Fig. 4

Touring car antenna: J, lead-in; O, end of wire; R, top; V, lining; Q, cloth, supporting wire; P, flaps; S, lead-in shielding; U, heavy wire; T, receiver.

occurs, but is easily corrected. All four condenser rotors should be fully meshed with stators when the handle of dial is in extreme left position. If the rotors do not track together, set them by loosening set-screws holding them to shaft; and, when re-set, again tighten set-screws. Now tune in a station in the neighborhood of four hundred meters, or slightly above the middle of the tuning range. Reduce volume control until signal is weak. Then screw adjustments on end of coil housings up or down until signal received is loudest. Circuits are now balanced with one another.

Noisy Reception

If the interfering noise is in the form of a series of crashes at irregular intervals persisting in all localities—even when the automobile is standing still—it is probably caused by atmospheric disturbances, commonly known as "static." This form of disturbance is most common during the summer and in unseasonable hot weather.

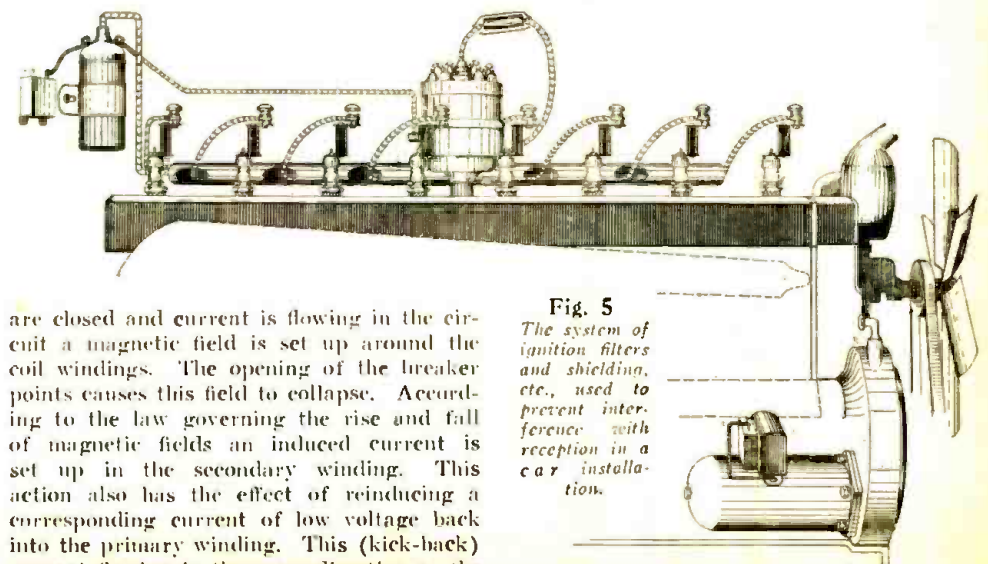

Fig. 5
The system of ignition filters and shielding, etc., used to prevent interference with reception in a car installation.

are closed and current is flowing in the circuit a magnetic field is set up around the coil windings. The opening of the breaker points causes this field to collapse. According to the law governing the rise and fall of magnetic fields an induced current is set up in the secondary winding. This action also has the effect of reinducing a corresponding current of low voltage back into the primary winding. This (kick-back) current flowing in the same direction as the

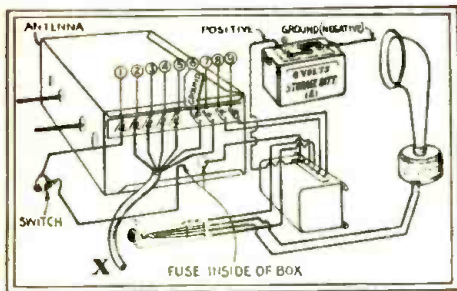

Fig. 6

Outside connections of the installation described last month, in which the audio output transformer and "A" filter are combined in the unit shown under the "A" battery.

ing a 1-mf. by-pass condenser across the output. In order to secure clear reception, it is necessary to keep the electrical system of the car in good order. Defective spark plugs, dirty or improperly adjusted breaker points will tend to cause interference. Faulty generator brushes and uneven commutator segments will also cause trouble.

Trouble Shooting

The following points may help in locating the source of disturbance when trouble is experienced from ignition interference.

Detune the set; if this does not reduce the level of the interference, then it is not coming in through the antenna, but being

fed through the battery wires. Most disturbances of this nature may be traced to the following causes: (a) Generator commutator; (b) Worn brushes; (c) Worn breaker points, or lack of adjustment on same.

When detuning the set reduces the level of the disturbance, then high-tension radiation is being picked up by the antenna. This may be due to any one of various causes:

(a) Inspect all high-tension wires, and make sure that all fit tightly in their respective bushings in the distributor head.

(b) Test all spark suppressors for voltage drop; replace anywhere the resistance is too low.

(c) Inspect the by-pass condenser on the ignition coil. Flash it with a 45-volt "B" battery. (Make sure it is on battery side of coil.)

(d) Remove any battery, horn, or other low-tension wires from the vicinity of the high-tension field.

(e) In cars where the ignition coil is mounted on the instrument panel, see if the shielding on the high-tension side is grounded. In Packard cars equipped with "Transitone" receivers, the coil is completely shielded in a copper can. Cars of Chrysler make also use the "Electro-Lock" cable between the ignition switch on the instru-

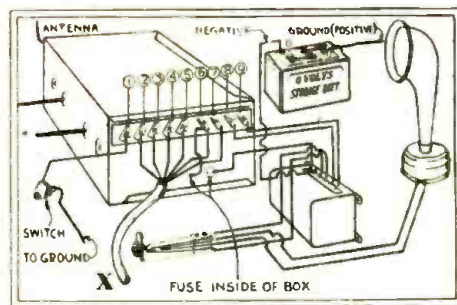

Fig. 7

Note similarity to Fig. 6, opposite. The differences are in the filament-circuit fuse and "A" connections, which vary with different makes of cars, as previously explained.

ment panel and the distributor. This cable must be shielded with Belden braid, and the shield grounded to the metal collars at both ends of the cable.

(f) Try placing a 1-mf. by-pass condenser across the panel; namely, the ammeter, electric gasoline gauge, lighting and ignition switches, or cigar lighter. If this procedure is carefully followed out, no difficulty should be experienced in finding the source of trouble and eliminating it. The accessibility of all connections in the simple circuit makes voltage tests and trouble shooting easy.

Why New Sets Use "Kilocycle" Dials

By H. B. RICHMOND

President, Radio Manufacturers' Association

MANY custom set builders will be interested to know that the "kilocycle" designation on receiving-set dials is becoming general; because it follows the adoption of the kilocycle standard by the Federal Radio Commission and scientific organizations.

The use of kilocycles, as the approved method of designating the location of a broadcast station, has become established beyond doubt. This is just the logical development of advances in the refinement of radio receiver design.

Radio sets were at first marked in num-

bers only. Sometimes dials used the 0-100 system; at other times the dials were graduated in geometric degrees. Both of these methods served only as reference points. They both made it necessary for the operator to fish for a new station. With the improvement of receiver design, it became practical to calibrate the dials. These dials were marked sometimes in wavelengths, sometimes in kilocycles, and occasionally in both. A few manufacturers went so far as not only to include kilocycles and wavelengths, but also add a reference scale. The use of this multiple system was as often

confusing as it was helpful to set owners.

The Federal Radio Commission and scientific organizations have adopted the use of kilocycles only; no cross-reference is being made to wavelengths. The broadcast band has been laid out on the basis of a 10-kilocycle separation between stations. The band extends from 550 to 1,500 kilocycles.

This uniform spacing makes a kilocycle dial a convenient reference dial as well.

Marking of dials of new, modern radio receiving sets with but a single scale, that of kilocycles, is an established manufacturing practice.

Locating Hum in "A" Eliminators

By J. F. RIDER

HUM in an electrified radio receiver installation may be due to the presence of a large value of A.C. component in the D.C. voltage available from the "A" eliminator. This unit, like the "B" eliminator, employs a rectifying device and a filter system and, just as in the case of the "B" supply unit, failure of the rectifier element and the filter system will cause a large A.C. component in the D.C. output.

Very little need be said about the rectifying element. In some cases this device fails after a short period of operation. In others it lasts for several thousand hours, but it should be understood that the unit has a definite operating life; consequently replacement will be necessary after a time and, if the complete "A" unit in question is a year or two old, consideration must be accorded to the rectifying element.

However, pronounced hum has been noted

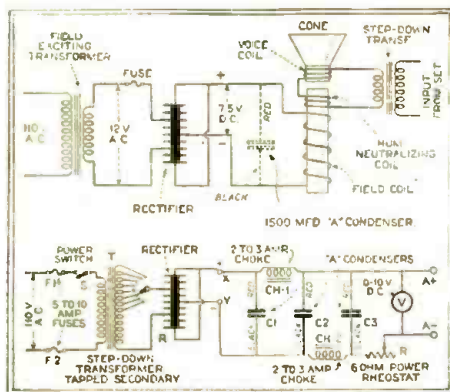

Above: Circuit for obtaining from an A.C. line low-voltage direct-current for the field coil of a dynamic reproducer. Below: Unit supplying filament voltage for tubes designed to operate in D.C. circuits.

with "A" units, when the complete device is only sixty or ninety days old. In this case the probable fault is the "dry" electrolytic condenser employed in the filter system. In contrast to the conventional type of filter condenser employed in the "B" eliminator, the requirement of the "A" condenser is a large capacity, several thousand microfarads, in a small space. To attain this objective it is necessary to employ a different type of condenser. To be exact, this condenser utilizes a film of oxide as the dielectric.

The design of this condenser is such that a certain amount of current (known as leakage current) flows through the condenser. If this current is appreciable it will gradually reduce the capacity value of the condenser; and, if this takes place, the filtering action of the complete filter unit is impaired and hum in the output circuit is the result.

(Continued on page 474)

New Radio Devices for Shop and Home

In this department are reviewed commercial products of most recent interest. Manufacturers are requested to submit descriptions of forthcoming developments.

VOLUME CONTROL WITH POWER SWITCH

As a further contribution towards simplifying the broadcast radio set panel, a combination volume control and power switch is now offered by the Clarostat Mfg. Co., Inc., of Brooklyn, N. Y. This device comprises the standard wire-wound volume-control Clarostat with an extension pin on the shaft, to trip a toggle power switch, mounted at the rear of the assembly. In this way, one knob serves the double function of turning the radio set on and off, and of adjusting the volume to any desired degree. A bakelite case, with metal end cap, protects the winding and contact member from mechanical injury as well as from dirt, dust and moisture. The device controls operation with a smooth, velvety action, without introducing noise into the radio circuit. The resistance winding is designed in standard tapers, of several varieties to match any desired curve, and in all values up to 50,000 ohms. The knob turns 300 degrees, as a volume control; and 40 degrees more to turn the power switch off and on.

NEW LIGHTNING ARRESTER

A very effective and compact form of lightning arrester, pictured in this column, has been developed and put into production by the Insuline Corporation of America, New York City. It is not only low-priced, but carries the manufacturer's confidence to the extent of a free \$100 insurance policy against lightning damage to the set which it protects.

The "Electrostatic" lightning arrester has an insulating base of glazed porcelain, on which are mounted (and sealed in against moisture) a small R.F. choke coil and a fixed condenser, in series between two binding posts which are to receive, respectively, the lead-in from the aerial and the lead-in to the receiver's "Ant." post. A third post, which is grounded, is connected to a high resistor, in series with the aerial, and covered by a bell-shaped metal cup. The set's

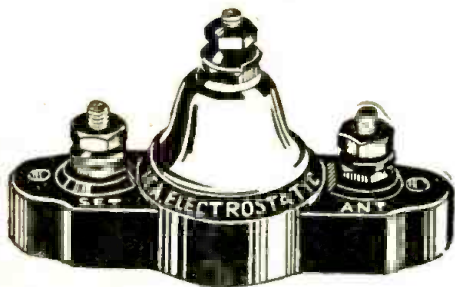

External appearance of the new lightning arrester, described above, which incorporates an R.F. choke in addition to the usual resistor.



The combination of snap switch and "Clarostat," pictured above, affords a very satisfactory volume control of the newer type and simplifies the panel arrangement.

coupling is therefore obtained capacitatively from the aerial; a method usually affording better selectivity with good pick-up. It is a precaution also against possible contact of other electric wires with the aerial.

The constants of the resistance, capacity and inductance values in the arrester have been selected to cause negligible reduction of signal strength, but to offer high resistance to "static" or atmospherics of high intensity. When the atmospheric voltage has reached a value sufficiently high, it leaps to the grounded bell, rather than pass through the high resistance between the aerial post and ground.

NEW DRY-CELL TUBES

With the requirements of a successful portable radio set, as well as a rural radio set, in mind, the DeForest Radio Company of Passaic, N. J., has just introduced two new dry-cell tubes: the "499" and the "422A" "audions."

Both differ from tubes of similar characteristics in having an oxide-coated filament, of large cross-sectional area. This makes for a non-microphonic tube, as well as one having ample emission over a long period.

The mutual conductance of the "499" is 600 micromhos, a very high figure compared with that of the standard '99, which it otherwise resembles in characteristics.

The "422A" has a filament emission averaging 50 milliamps, with a passing mark of 25. At 3.3 volts across the filament, it draws only 60 milliamps; thus making it very economical of batteries. Its recommended plate voltage is 135, screen-grid voltage, 45; control-grid bias, 3 volts, negative. It therefore should be used with the proper "C" battery to give the correct bias; 50 ohms would be needed to give a 3-volt drop at 60 milliamperes. The mutual conductance of the tube is 465 micromhos at 135 volts, as against 350 for the standard '22s.

NEW VOLUME CONTROLS

The "Type A Super-Tonotrol," recently introduced by Electrad, Inc., New York City, has been modified and improved; the new development being known as the "Model B," illustrated here. The metal-shell, rectangular 5-watt "Model A" variable resistor is obtainable in three standard ranges (100,000-ohm tapered, 25,000-ohm tapered [for pick-ups], and 25,000-ohm tapered for use as the volume control in the antenna circuit of a receiver) as well as other and special designs for manufacturers; it has now been supplemented by the "Model B" which has a round molded bakelite shell 2 1/8-in. in diameter. The new model has a power rating of 3 watts, and is of the single-hole-mount type; it may be connected also as a potentiometer.

These resistors may be mounted in tandem for the control of multiple, isolated circuits. For example, a tapered-resistance type may be used in the antenna circuit, while one of uniform variation, operated by the same shaft, controls the grid circuits. The resistance variation in the antenna circuit is extremely small during the first half of the knob's rotation; which assures smoother control of powerful signals.

Both models have the same general construction and operating characteristics. The contact is a pure silver, multiple type which actually grows smoother with use; owing to a microscopic deposit of metallic silver from the contact on the resistance element. The specially-developed resistance element itself is fused at high temperature to the surface of a vitreous-enamelled metal plate. The result is greater permanence and accuracy of resistance values and more rapid heat dissipation.

Tests by the manufacturers indicate a reduction in resistance value, due to the deposit of silver on the graphite, of only 5% for the 100,000-ohm type unit, and less for the lower resistance units, over a period estimated to equal ten years' service.

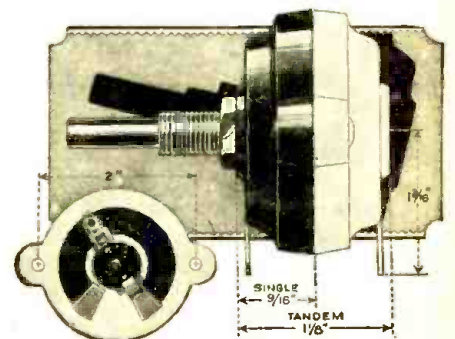

Views of the "Model B Super-Tonotrol," showing construction as well as dimensions. These resistors may be mounted in tandem for single-shaft control, with different rates of variation for each circuit.

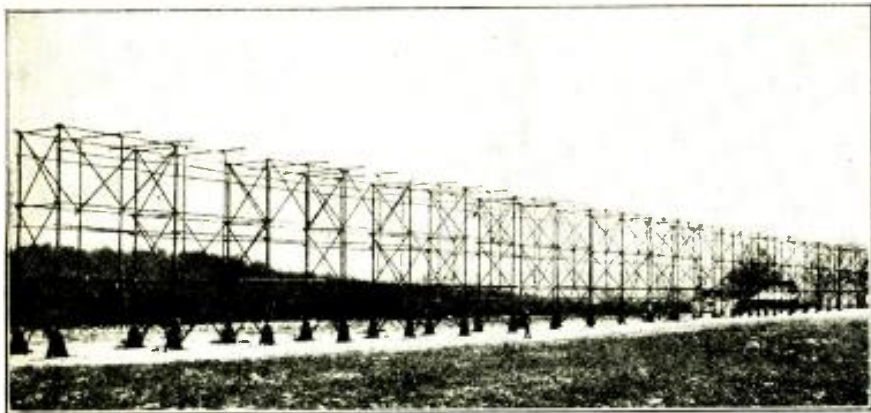

Above, one of the antennas at the short-wave receiving center of the American Telephone & Telegraph Co., located at Netcong, New Jersey. These complicated antennas pick up the same signal along the length of many zones. With these, telephone communication with the "Let's talk" is commercially carried on.

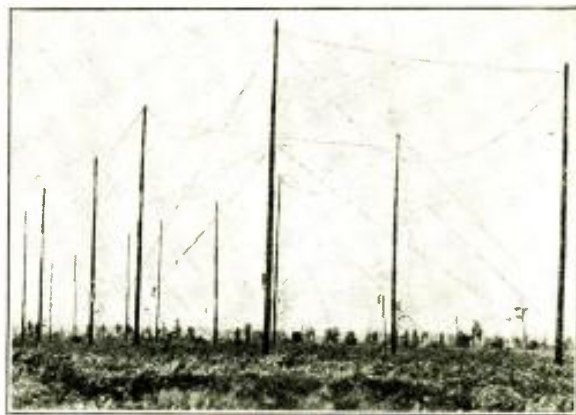

A four-bay antenna for short waves, located at the Radio Corporation of America's receiving center at Rocky Point, Long Island, N. Y. Here transoceanic broadcasts are picked up to be relayed to American stations.

New Developments in Short-Wave Radio

By LAURENCE M. COCKADAY

IN short-wave radio, I believe, lies the world's real wealth, for communication and control purposes of all kinds, and it is to the wavelengths below 200 meters (how far below we cannot guess) that we shall look for the more startling kinds of developments of future radio. It was in the year 1912 that the first Radio Act handed to the small band of radio amateurs in the United States a parcel of wavelengths, of 200 meters and under, with the expressed idea of making it possible for them to continue their experiments without interfering with the rapidly-growing commercial services on the higher waves.

It was then considered that the wavelengths below 200 meters were not of much use for commercial purposes with the need of distance transmission and reception; and the amateurs would be able to dabble around and have a good time on these short waves, even if they did not accomplish much.

Little was it believed, at that time, that during the years 1928 and 1929 high frequencies would become applicable for commercial communication. Much credit must be given to the amateurs who, experts confidently believe, were responsible for the remarkable development which has shown and proven that the high-frequency channels are not only more efficient for long-distance communication, but invaluable in any number of ways.

Short Waves Now Indispensable

Today, we find short wavelengths or high frequencies being used for every conceivable means of communication. They are serving as the most reliable and consistent means of transatlantic communication, and have practically antiquated the longer-wave apparatus which served so adequately for more than a decade. It is possible to converse with any city in most of Europe and part of South America—and even with the *S. S. Lexington* in the mid-Atlantic—from any one of the 19,000,000 telephones in the United States, through the marvelous application of these channels. In addition, aircraft are finding their way through the



Mr. Laurence M. Cockaday, we are certain, needs no introduction to our readers.

For several years, Mr. Cockaday was the editor of *POPULAR RADIO*, during which time he contributed an enormous amount of important radio literature to the art; at the present time he is a member of the faculty of New York University.

Mr. Cockaday himself is an inventor of no mean order, having developed a number of radio circuits which in their time were famous, and anything that he may wish to say to our readers will be read with more than usual interest.

We have prevailed upon Mr. Cockaday to write a monthly article for each issue of *RADIO-CRAFT* for the coming year; the present article is the first of the series.

severest of fog and bad flying weather through visual-beacon signals transmitted on short wavelengths. Television is now being used solely on these bands. And a host of services are carrying on experiments, which may ultimately lead to new uses for these already valuable high-frequency bands.

It is, therefore, necessary for all experimenters and Service Men alike whose business is wrapped up in the future of radio, to keep informed of radio developments on these short waves; nothing is too much a detail, nothing is too small to be missed, if we really mean to make a success of our work.

That is one purpose of this article; to give a clear idea of short-wave development and what it has accomplished, as well as some of the things it will or may accomplish in the future.

Short Wave Discovered First

It is a general supposition that the short radio wave is a new thing; this is not so. The French physicist Biot noticed the first short-wave radio transmission, and probably the first radio transmission of any kind, long before he or anyone else knew or suspected there was anything like radio, when he saw a pair of frogs' legs jump every time he set a high-voltage machine in action on the other side of his laboratory.* Heinrich Hertz utilized short waves in the oscillator circuits that bear his name. His energetic successor, Marconi, used these same waves for his first "wireless" transmissions and receptions of messages. Later, however, Marconi increased the size of his antennas and obtained what he thought better results; and all the world followed him up to the high wavelengths.

Of course, many of my readers could easily solve the reason why early experimenters had better results with long waves;

*Frogs' legs, when freshly killed, were used a great deal by early scientists as detectors of electricity. When electrified, they jumped, because of nerve impulses acting on the still live muscle tissues.

the transmitting apparatus used in those days was of the "spark" variety, and suitable amounts of power can be generated by that method only on reasonably long waves. It takes the vacuum-tube method of continuous-wave propagation to effect real efficiency on short waves.

And so we are now coming into a marvelous short-wave era, where almost anything is possible in feats of radio transmission and reception over long distances. We are learning some wonderful things and this knowledge is not going to waste! It is being put to good use in turning out services to humanity that are of the greatest importance in ordinary, every-day life!

Telephoning to Ships at Sea

Improved methods of transmission as well as more advanced reception systems are widening out the scope of short-wave communication all over the world. The most recent practical development of short-wave transmission is the installation of direct telephone service with the *Leviathan*.

Development of the system involved years of research, and is the culmination of actual experiments which have been completed by the Bell Telephone Laboratories during the past eight months. Two-way conversations with the ship proceed as easily as though wires were carrying the voices half-way across the Atlantic. The apparatus used aboard the *Leviathan* is not much unlike the usual short-wave telephone equipment.

Transmissions from land are sent through a twenty-kilowatt short-wave telephone station at Deal Beach, N. J., which formerly served as the American link in the international telephone service with England. This transmitter feeds power to a large directional-type antenna, which casts a beam signal in an arc which includes the usual transatlantic course of the *Leviathan*.

During the series of experiments which preceded the inauguration of the mid-ocean telephone, it was found that, in order to maintain reliable communication with the liner it is necessary frequently to alter the wavelength or frequency of the transmitting station at Deal Beach. Accordingly, a unique crystal-controlled oscillator was designed, whereby it is possible to switch the transmitter's frequency, selecting one of

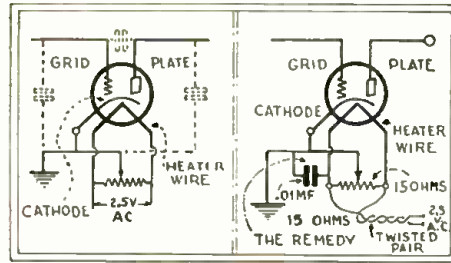

Fig. 1 **Fig. 2**
The inductance of the potentiometer introduces complications in an A.C. short-wave tube. This, Mr. Cockaday has found, is readily overcome by the by-pass condenser shown in the diagram at the right.

four which happens to best cover the span under the conditions encountered.

Skip-Distance Elimination

The necessity of change in frequency obviously is due to the skip-distance phenomena of high-frequency transmission. The four frequencies used for this purpose are 3,121, 4,116, 6,515 and 8,630 kilocycles. A similar arrangement is employed on the *Leviathan*, although only three channels are there available. These are 3,218, 5,618 and 8,150.

Changing from one frequency to another involves only the flipping of a switch on the part of the operator at the transmitting station. Separate crystal-controlled oscillators, tuned to each of the frequencies, are ready for operation at a moment's notice, and may be switched into use. Each of these units is thermostatically controlled, facilitating accurate frequency-maintenance.

Receiving is accomplished through ultra-sensitive, but more or less conventional screen-grid short-wave receivers. One of the unusual features of these instruments is the use of an automatic volume control which facilitates a constant voice level. One of these receivers is used aboard the *Leviathan*, and is maintained by an operator, who keeps in constant touch with the land station throughout the entire voyage.

Picking up the *Leviathan's* signals on land, however, is planned with foolproof methods. Five separate receiving stations have been erected, about an equal number of miles apart, in the vicinity of Ocean Gate,

N. J. All of these stations maintain a constant vigil; and the one reporting the greatest signal intensity is used for the reception of the *Leviathan* end of the conversations.

This idea of receiving sets located in different areas brings up an interesting development in combating fading and skip-distances, those enemies of long-distance short-wave communication. It is now reasonably certain that short waves are transmitted around the earth by bouncing back and forth between an ionized layer of rarefied gas (the Kennelly-Heaviside layer), high up in the earth's atmosphere, and the ground itself. This has been proven by a series of experiments by numerous research workers by what is termed the "radio-echo" method, and is further substantiated by the recent work of Hafstad and Tuve.*

Multiple Fading Areas

This idea of a number of stations located relatively nearby, but in a number of fading areas to do away with fading, and the idea of using different wavelengths for various distances of transmission, have to a great extent done away with loss of signals and enabled, this year for the first time, the reception over great distances with relatively even signal strength.

A similar idea used by the Radio Corporation of America has made possible the reception on short waves of complete broadcast programs from Germany, Holland, England, France, Australia and New Zealand, to be rebroadcast over the great chain networks in our own country. This system utilizes a number of antennas, spaced a few thousand feet apart. Connected to these antennas, through a balanced transmission line, are separate receiving sets. These receivers are then tuned to the same short-wave signal, and the output of each is rectified and amplified. The parallel signals are then kept almost constant; for, when fading occurs at one antenna, the signals are strong on the next one, and the additional advantages of an automatic volume control give virtually even signal strength.

(Continued on page 471)

*Note: "Further studies of the Kennelly-Heaviside layer by the echo method."—Proc. I.R.E., Sept., 1929.

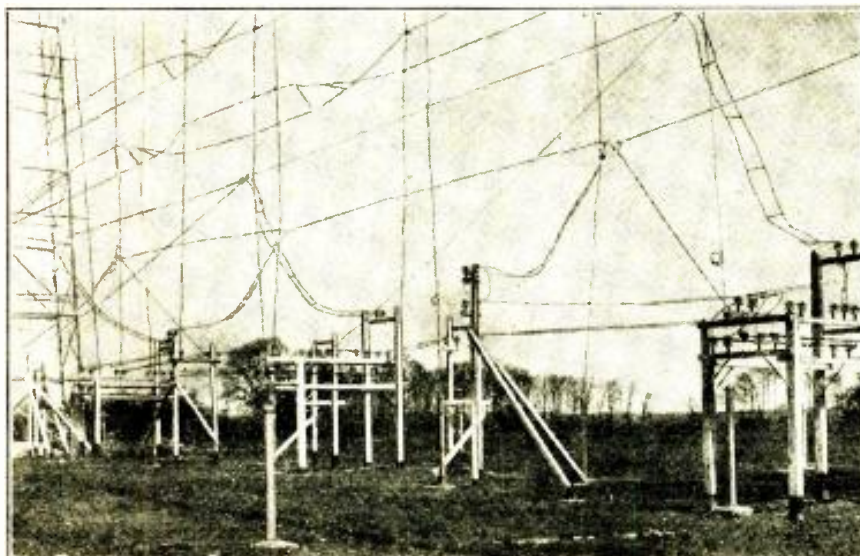

A part of a short-wave transmitting antenna of the American Telephone & Telegraph Co's. new center at Lawrenceville, N. J., used in transoceanic work. Here we have part of the antenna "curtain" in one of the "bays," showing the connections from the transmitter to the antenna which carry the signal current.

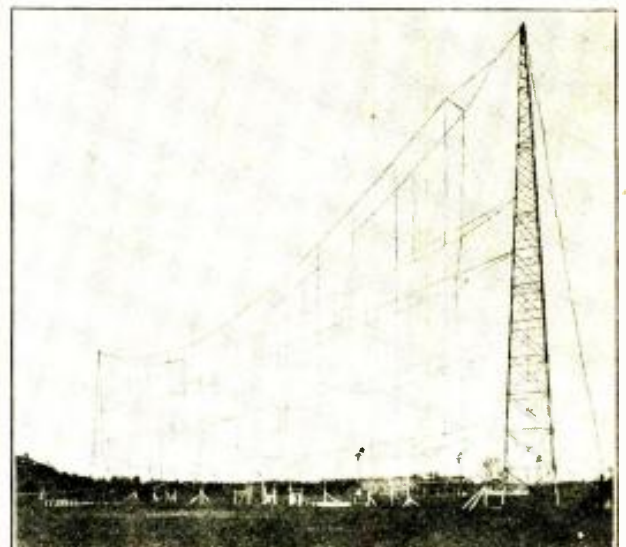

This is a general view of the new station WOO at Deal Beach, N. J., which many short-wave listeners have heard testing with the *Leviathan*, and its transmitting antenna. (Photo courtesy Bell Telephone Laboratories.)

SHORT WAVE CRAFT

Short-Wave Transmitter Design and Operation

By A. R. HAIDELL

WHEN short-wave phenomena were novel, and the high frequencies were not thoroughly understood, the amateur was content with any reasonable layout that would put power into an antenna; but times have changed, short-wave apparatus has improved greatly, and greater distances are now covered with lower power. The first transmitters operated on the short wavelengths gave very unsteady signals which were difficult to copy at the receiver; the tone was poor and the distances covered were comparatively small. Constant-frequency oscillators of excellent design are needed to-day. Crystal-control transmitters have advantages; but the complicated necessary amplifying arrangements are difficult of operation when one is not thoroughly acquainted with their adjustment. By careful adjustment of the set to be described, a good, crystal-steady note can be obtained. The writer has designed a 50-watt transmitter that gives excellent results with a minimum of apparatus, and its description should interest short-wave enthusiasts.

Construction of Special Coils

Inductances in common use are often unsatisfactory because of their high "distributed capacity." This capacity would not be particularly objectionable if poor dielectrics were kept out of the field of the coil, but this is difficult, if not impossible, to do in an ordinary set. However, a reduction of this capacity is desirable and may be effected by using air as the dielectric wherever possible.

Ordinary copper tubing, if available, makes coils of good rigidity but, even when

spaced with a considerable distance between turns, the distributed capacity is high. It is much better to use some thin material with plenty of surface, such as copper ribbon, wound flatwise, thus keeping the distributed capacity low and allowing one to use a

from the transmitter will be slightly less, but the frequency will be steadied remarkably; and this is important. The use of a variable condenser across the inductor allows one to vary the wavelength of the transmitter between wide limits; and such a flexible arrangement is of value to the experimenter, especially in the narrow bands. When there is QRM on one wave, one simply changes to another.

An inductor having low distributed capacity may readily be constructed from copper ribbon, such as that found in the coils of a Ford magneto. One coil will furnish enough ribbon for a 40-meter primary and, if a larger one is desired, this material is very easily soldered.

There are many ways to support the ribbon; but perhaps the easiest is to use small strips of celluloid, which are cemented in place with collodion. A round, wooden form about 3½ or 4 inches in diameter should be constructed. Two celluloid strips, about an inch wide, are evenly spaced about the circumference of the form and the ribbon is then wound on; allowing about ¼-inch space between turns. Paint the celluloid under the strips with collodion (see Fig. 1) and secure the ends of the copper strip to the celluloid by bending the copper back upon it. The inductor L1 shown in the illustrations has 14 turns and, with its distributed capacity, oscillates naturally at about 25 meters. The variable condenser brings the wave anywhere within the 40-meter band with comparative ease.

Coupling the Inductors

The secondary L2 is made of the same material as the primary, and is mounted on a glass plate, as shown in Fig. 2. (The usual practice of allowing the coils to lie on any table-top is not to be recommended.) The glass plate protrudes over the side of a cardboard box, to which it is cemented. This box is an ordinary cardboard affair such as a 22½-volt "B" battery box; it may be trimmed down to give the desired height and the two cardboard sections are held together by passing a string through them from one side to the other.

Instead of bending the ribbon back on itself, as done with the primary, leave a 6-inch length at each end; these ends may be straightened, extended to the ends of the glass, and bent over so as to hold the coil rigidly in place. If desired, clips may be used to attach various antennas, and these are clipped to the ribbon. This arrangement allows one to vary the inductive coupling; moving the coils so that there is less area facing one another secures nearly the same

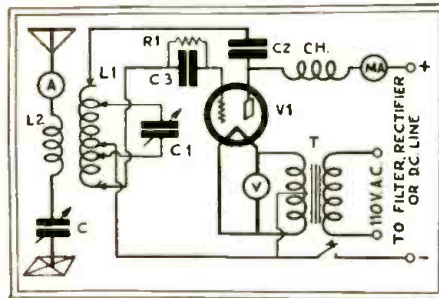

Fig. 3

The simple Hartley circuit of a transmitter which may be constructed with a number of home-made components.

"lumped" capacity such as a small variable condenser.

In ordinary oscillator circuits, the capacity between plate and grid is in parallel with the oscillator inductance, and any change in tube capacity will change the frequency of the emitted wave. If the lumped tuning capacity in parallel with the inductance is high, the small change in capacity caused by heating of the tube elements will have little effect. It is therefore desirable, in order to obtain a steady wave, to use somewhat less inductance and somewhat more capacity. With a small inductor, shunted by a comparatively high capacity, the output

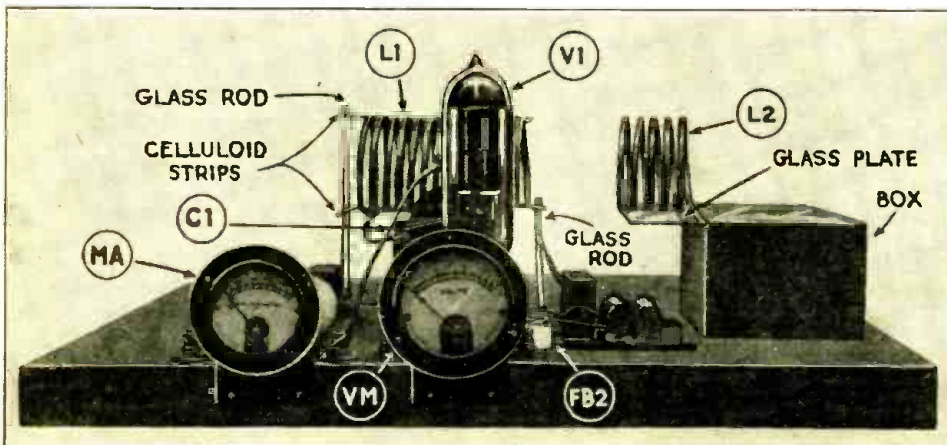

Fig. A

This picture shows the 50-watt transmitter constructed by Mr. Haidell. It may be compared with the layout plan on the next page. Power grid leaks are shown at the right of the grid condenser, beside the fuse block which mounts the transmitting bottle.

effect, capacitatively. With small effective area, the coils can be placed close together; although it would probably be better to keep them farther apart for a given coupling.

Other Parts

The variable condenser for tuning may be a bakelite-end affair of 23 plates or so. It

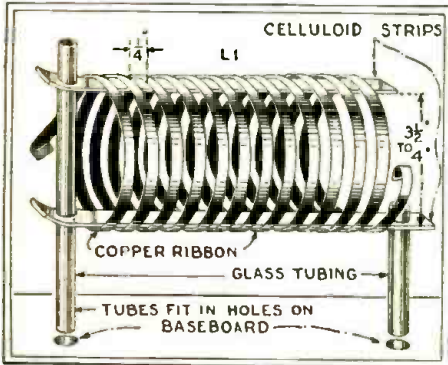

Fig. 1

The self-capacity of the coil shown is much less than that of one made of copper tubing; its low inductance permits better frequency control.

should be "double-spaced," by removing alternate plates; so that the high voltage will not spark over. A 10-plate, double-spaced receiving condenser will serve for all average conditions. It is mounted on a piece of scrap bakelite which is screwed to a small base; this base is secured to the main baseboard by a pair of brass screws. The condenser may be fitted with a suitable dial upon which the wavelengths may be marked; this allows one to keep schedules on a particular wave and yet do a little experimenting on different waves at other times. Certain wavelengths will work better at certain times of the day or night.

The radio-frequency choke coil should have a rather small diameter and be wound of small wire; a good 40-meter choke may be wound of 100 turns of No. 26 wire on a piece of one-inch paraffined cardboard tubing. In order to keep its field from the other coils as much as possible, set it away from them, with its axis at right angles to those of the other coils.

A low-cost tube socket for a 50-watt set may be made of two telephone fuse-holders; these are well-glazed and have small terminals set into the porcelain. Brass strips are soldered to the tube terminals and attach to the fuse-holder by means of its screws.

The coil supports are ordinary glass rods which are set into holes drilled in the baseboard. The celluloid strips are punched, so that they fit tightly over the glass rods and are thus held in place. Any convenient height may be used for the inductor, and the rods are made of a length to suit.

All parts not otherwise well-insulated are mounted on pieces of insulating material which are screwed to the baseboard. The power-supply posts are mounted directly on the baseboard. Binding posts, that may be screwed directly to the board, are most convenient for this purpose. Those shown in Fig. 4 were taken from old telephone equipment.

The clips used for an inductor of this type should not be too large for easy removal. The connecting wires are soldered to the clips; and the condenser leads should be heavy.

Wavemeter Construction and Calibration

A wavemeter will now be required for adjusting the transmitter. It is about the most useful instrument a station can have; but it is surprising to note how many do not have one. There is no excuse for this; because a wavemeter is so easily constructed. As diagrammed in Fig. 9, an instrument may be made of a 3-turn coil, 3 inches in diameter, an ordinary variable condenser VC of about 23 plates or so, and a flashlight-lamp socket with a small 1 1/2-volt lamp, all connected in series. This arrangement will tune from about 20 meters to 50 meters; while a 9-turn coil will usually allow one to tune from about 45 to 110 meters (a wide range).

Connect the wavemeter coil to the receiver, which is oscillating weakly, and vary the condenser until the familiar "resonance click" is heard. This shows that the wavemeter is tuned to the same frequency as the receiver and, if a station, the wavelength of which is known, has been tuned in, the condenser dial is to be marked with this wave-

length. An S.L.C. condenser will give an approximate straight-line relation between wavelength and dial setting from 25 to about 85 on a 0-100-scale dial. By calibrating a few points on the dial, therefore, intermediate wavelengths may be estimated with fair accuracy. On the short waves, the number of turns necessary in the wavemeter coil is small; and it is desirable to confine

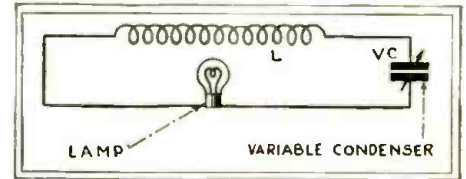

Fig. 9

The wavemeter for a transmitter has sufficient input to light a lamp in its circuit.

the effective inductance to the coil itself by keeping the leads short. In order to do this, the coil must, as a rule, be mounted at the rear of the condenser. It is sometimes convenient to be able to read the wavelength from the back of the condenser, also; though the dial cannot be seen from here, this may be readily done by scratching radial lines on the plate at the end. Set the dial at say 2, run a pointed instrument, flush with the stator plates, over the rotor plate and mark the latter so that the wavelength may be read; next move the dial to say 4 and repeat the operation, proceeding around its circumference until the end plate of the condenser is covered with radial lines, evenly apart. These lines may be marked to read directly in wavelength if desired, and with this arrangement the wavelength may be read either from the front of the condenser by means of the dial, or from the rear of the condenser by means of the graduated end-plate. This is often a convenient feature when exceptional accuracy is not desired.

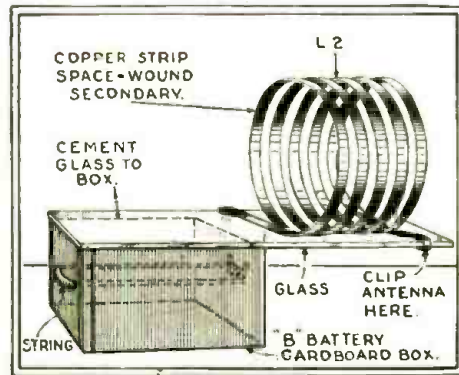

Fig. 2

The secondary or antenna coil of the transmitter may be satisfactorily mounted in this way, which permits the coupling to be adjusted at will.

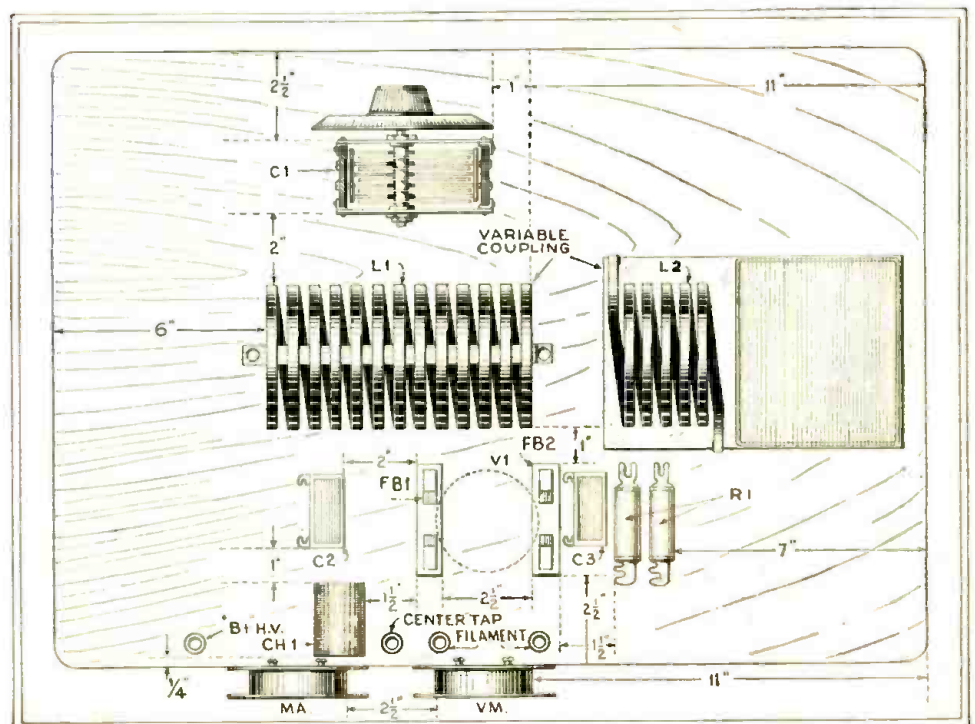

Fig. 4

The layout used by Mr. Haidell in his transmitter is a convenient one. Everything is readily accessible, and there is the least amount of undesirable interaction. The insulation throughout must be good.

With a sensitive wavemeter, one can secure a good deflection of the indicator at a distance of several feet from a 50-watt oscillator; this shows that any conductors within a radius of several feet, whether metallic or moist wood, will have currents set up in them and consequently cause an apparent increase in resistance in the circuit parts, due to losses. In this set, the primary has been supported on a pair of glass rods, away from the base, variable condenser C1, and other apparatus.

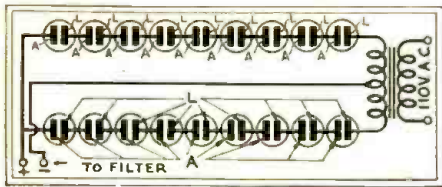

Fig. 5

With a center-tap transformer, the rectifier jars may be arranged as shown here.

Several amperes usually flow in the oscillating circuit, consisting of the condenser and the shunt inductor; consequently one should make the condenser leads to the inductor heavy in order to cut the heat loss as much as possible.

Adjustment of the Hartley Circuit

The adjustment of the Hartley circuit (Fig. 3) used in this set will be next described. The oscillatory circuit consists of C1 and that part of the inductor or L1 which it shunts. The following method is suggested for adjusting the circuit:

Set the plate clip at one end of the coil and the grid clip at the other; and place the filament clip midway between them. This arrangement will now oscillate quite strongly without the shunt condenser C1, but at a very short wavelength. The wavelength is raised by connecting the two condenser clips at a few turns on each side of the filament clip, as diagrammed. The filament clip may be correctly set to secure good output before C1 is connected; and the condenser is then brought into circuit. If it is necessary to use the total capacity of C1 to raise the wavelength to the desired value, shunt the condenser across more turns of the coil; and, if the condenser sparks over, use fewer turns, with more capacity, for the given wavelength. The condenser clip nearest the grid end of L1 should be nearer than the other condenser clip to the filament clip.

Less "grid turns" will give a better note; but there is a certain minimum, at which operation is best.

After the transmitter is oscillating on the proper wavelength, with good output, with fairly low plate current, the secondary, or antenna coil L2, is coupled to the primary L1 and tuned into resonance with it; slight readjustments of the filament clip may be necessary to secure good stability. Keep the two inductors at least two inches apart; a greater distance is to be recommended for the coils used here. The antenna current should be about 85 per cent. of the maximum obtainable. For an ordinary 50-watt tube, one can secure fine results with about 800 volts on the plate and a plate current not exceeding 50 milliamperes. It is interesting to note that many amateurs use higher plate currents than this on smaller tubes. It is practically impossible to do so with ordinary oscillators, while maintaining a steady wave.

The Antenna

The antenna often causes trouble; a few words may be to the reader's advantage. For operation at 40 meters, the antenna and

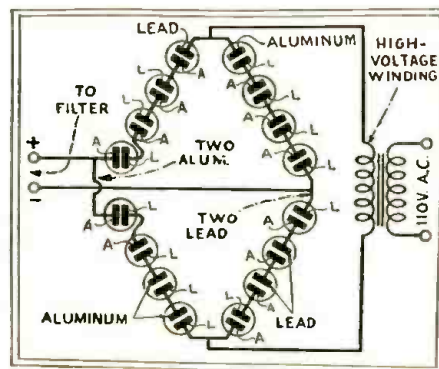

Fig. 6

The standard "bridge" circuit of a rectifier is shown here. The number of jars must be proportioned to the voltage rectified; each will carry about 30 volts drop.

counterpoise should be each about thirty-three feet long; if the counterpoise is near, and parallel to, the ground (usually the case) make it about two shorter, or thirty-one feet (these lengths are total length of wire to the set). L2 should be connected between the two and it is convenient to place the resonance indicator A in the antenna, and the series condenser C in the

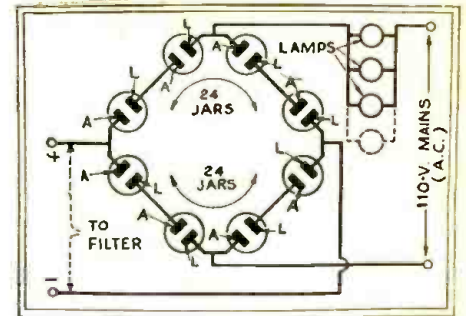

Fig. 8

To "form" the necessary film on the rectifier plates, they are put under load for a few hours in this manner.

counterpoise, lead to the coil. In order to bring the antenna into resonance with the oscillator (which, by the way, is absolutely necessary in order to know when full power is put into the antenna) vary the series condenser until the antenna resonance indicator shows maximum current.

Another common source of incorrect operation must be avoided by fastening the antenna and counterpoise securely; so that there can be absolutely no swinging which will change the capacity, and hence the fundamental wavelength. This will cause "swinging" in the distant receiver or even "fading," in extreme cases, as the circuit swings at its point of resonance.

The capacities of the grid- and plate-blocking condensers are usually not very critical. Good condensers for this purpose can be made from thin sheet copper with pieces of ordinary window glass for insulation. Let the window glass overlap the copper foil and arrange alternate pieces of glass and copper; make connection to every other copper strip by means of soldering small wires to it. The other lead makes connection to all the remaining alternated strips. With thin pieces of glass, and a few layers of it as described, it is easy enough to make a highly-efficient condenser with a capacity of .001-mf. or so. The ordinary 43-plate variable air condenser has a capacity of .001-mf. and with glass, the dielectric constant is much higher. This permits the use of less foil area for the same distance between conductors. Values as small as .0001-mf. can be used, if available. The glass at the two ends of the condenser may be extended, and these extensions used to mount the capacity. Set the glass extensions over the ends of a piece of wood of the correct size, after clamping the pile of glass plates together with two pieces of wood and a few wood screws; and fasten the glass to the wood by means of screws having washers which fit over the glass at its edges (Fig. 10).

Technical Comments

The amateur usually cares little about actual efficiency from the standpoint of current consumption, since this shows up as a mere trifle in the electric-light bill; his object is to secure maximum output with the available equipment. It is well to bear in mind, however, that a steady signal at perhaps three-quarters the output will usually carry better, and be more easily identified, than the note which wobbles or "climbs" as the tube elements become heated. It is well to note the causes of losses, so one can adjust for the best practical efficiency.

Although this set uses a 50-watt oscillator, any small tube (such as an ordinary

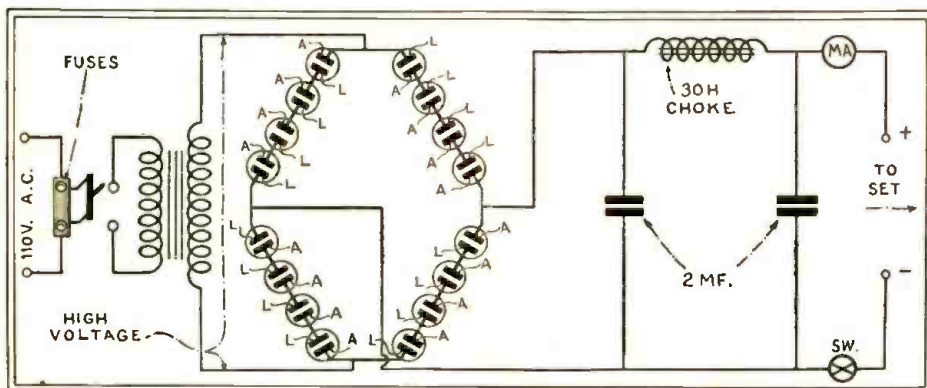

Fig. 7

The complete circuit of an A.C. rectifier supplying plate current to a transmitter, such as that described in this article. A heavy-duty choke is required, and 2000-mf. (D.C. rating) condensers.

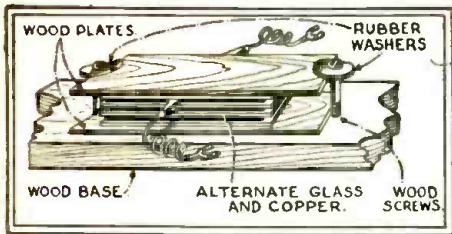

Fig. 10

A suitable blocking condenser (C2 or C3) for high voltage is quickly built up in the manner shown here.

7½-watt type '10 may be used. With the smaller tubes, correspondingly lower plate voltages must, of course, be used, and the

filament voltage should also be lower. This set arrangement may be used as a small receiving-tube oscillator at the start, with perhaps 150 volts of dry battery to furnish the plate potential. Any standard "B" power unit may be successfully used to furnish the desired voltage.

If low power is to be used temporarily, it is advisable to purchase such apparatus that it will not be necessary to replace any of it when higher power is to be substituted. The type of parts shown here is such that practically any power, within reason, may be applied by merely choosing the proper plate and filament voltages.

Panel-mounted layouts are sometimes more

portable; although it is doubtful whether any panel-mounted outfit can be made as attractive as one neatly laid-out with plenty of air between parts, and it is certain that the latter design gives the greater efficiency. The recommended layout of the short-wave amateur transmitter described by the author is shown in Fig. 4.

Chemical Rectifiers

Practically all amateurs operate their transmitting equipment from the A.C. mains and employ a rectifier; the latter often causes difficulty. The chemical rectifier is in general use, it is economical and easy to

(Continued on page 473)

Portable Phone System for Adjusting Transmitting Antennas

By L. B. ROBBINS

AFTER one has been initiated into the amateur transmitting game he commences to experiment with antennas, etc., to find the best possible means of radiating his signals. The current- and voltage-feed Hertzian systems seem to be in favor with many amateurs; but the difficulties experienced in locating the proper point for attaching the feed wire from the set seem to present the greatest problem.

The scheme illustrated in the accompanying diagram was used for this purpose and has been found an excellent means of communication between the operator at the transmitter and the one doing the adjusting on the antenna. Usually such antennas are close enough to a roof so the helper can walk along and place the feed wire at the desired point.

If not, then a short piece of metal tube can be soldered to the feed wire; slid over the antenna; and operated back and forth from the ground by strings pulled either one way or the other.

The phone system consists of two regulation headsets, a length of double-strand insulated wire and a "C" battery. Disconnect one phone from the headband at each set. Then connect the phone cords to the long cord by clips or phone tip connectors, and insert the "C" battery somewhere in the line. Run the long cord from the operator's point to that of the helper's; taking care to keep it as far as possible out of the field of the feed wire.

Each person uses the free phone as a transmitter and holds it in one hand for the purpose. Of course the antenna has the usual meter or light bulb in its center for adjustment readings. As the best meter-reading occurs, the operator converses with the operator at the set and vice versa; and thus they are able to keep in constant touch with each other. This enables them to get the most efficient readings at the transmitter as well as at the antenna, and insures the most efficient operating point.

The "C" battery can be provided with a switch to cut it out of the line when not in use, if desired, and thus prevent running it down sooner than necessary.

After the best operating point is obtained the feed wire should, of course, be soldered permanently to the antenna.

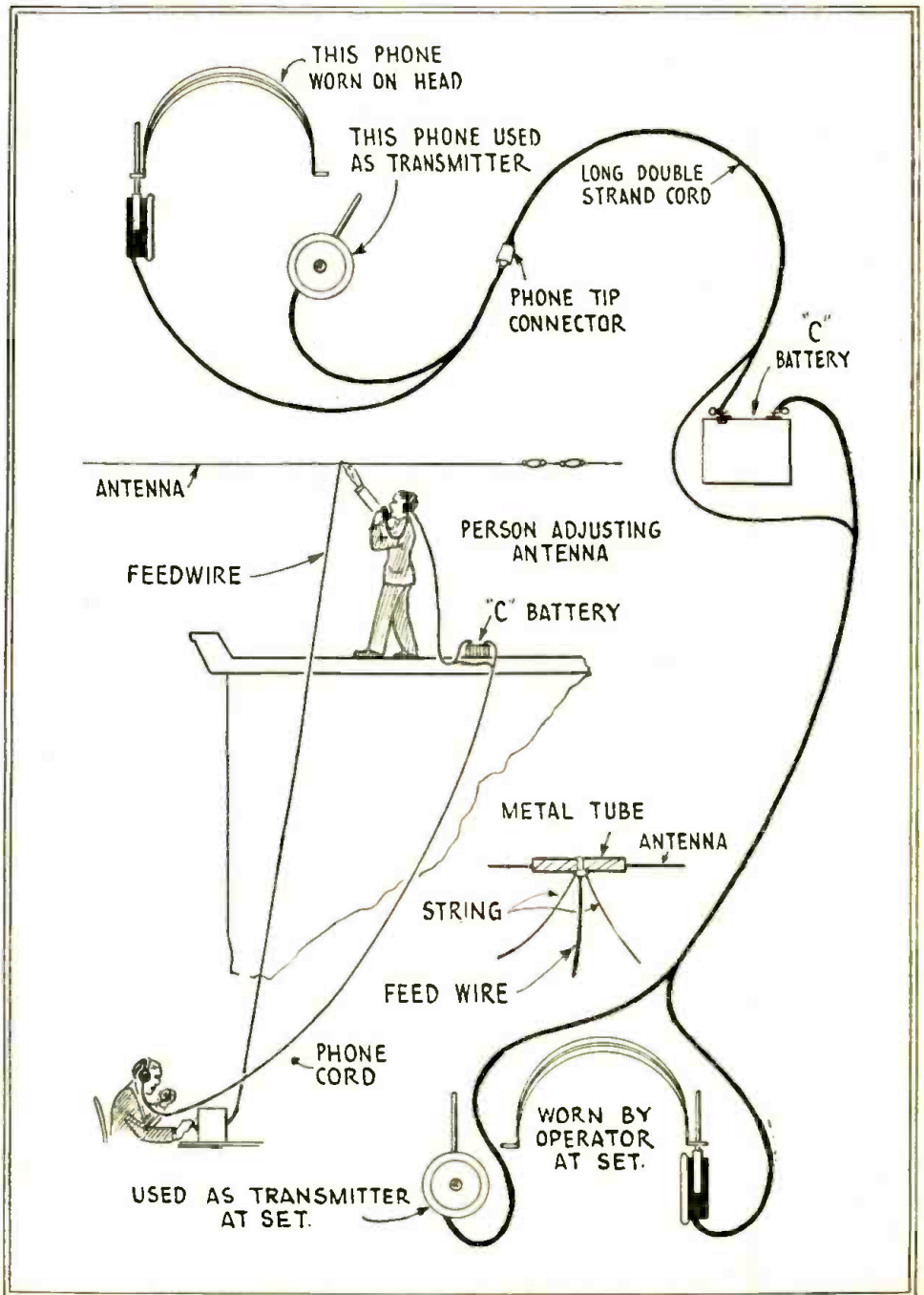

The problem of antenna adjustment, so laborious by cut-and-try methods, is quickly solved with one assistant and the phone system shown.

Image Reception With a Radiovisor

(Part II)

A review of the present state of television broadcasting and a discussion of the practical problems of the receiving operator

By D. E. REPLOGLE

IN the preceding issue of RADIO-CRAFT, a description of the new Jenkins radiovisor, and its mechanical novelties, was given by the writer. Some account of the methods of television broadcasting now in use, and of the results which may be expected by the experimenter, will be of equal interest; together with practical hints on the operation of a television receiver and reproducer.

In the first place, television broadcasting, at the present time, is done almost entirely on the basis of the 48-line image, at the rate of 15 frames or images per second; which has been adopted as standard, at least during the present stage of the art of television.

Why 48-Line Television?

Of course, the present-day standard of "48-line" television leaves much to be desired from the standpoint of artistry; just as the coarse half-tone screen of newspaper photographs is hardly to be considered a work of art when compared with 200-line screen illustrations on coated paper. However, it is a case of compromising between art and mechanical considerations. In the case of radiovision, we must, for the present, analyze, transmit and reconstruct our images in terms of 48 lines or horizontal strips. In order to represent animation, the complete

picture is flashed at the rate of fifteen times per second.

At first thought, a 48-line picture seems hopelessly crude. Many have compared the 48-line radiovision presentation with the coarse screen of the usual newspaper half-tone, taking a 18 x 48-dot section and representing that picture as the corresponding detail of the standard radiovision picture. Such a comparison is misleading.

While it is true that the radiovision picture is represented by 48 parallel lines or strips, it should be noted that each line is not broken up into separate dots or elements as in the line of half-tone dots. Instead, the line is a continuous one, made up of delicate variations of luminosity. Therefore, the radiovision image is limited as to detail by its strips as a whole, and not by lack of detail in the individual strips. This accounts for the unexpected degree of detail that can be obtained with the 48-line radiovision system.

There has been too much tendency to declare the 48-line image too crude to bother with. Yet in our recent developments, we have found it possible to handle standard motion-picture film with as many as three figures and some background, in our transmitter, and then reproduce the same at a remote receiving point, with sufficient detail

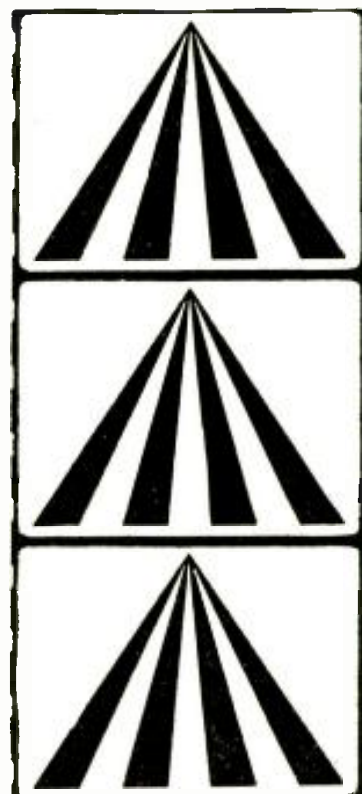

Fig. 1

Here is a specimen of the motion-picture film which is run through a television projector to facilitate resolution at the receiving end.

to follow the story. Of course "it can't be done;" but we have nevertheless gone ahead and done so! Our recent results convince us that the 48-line image has excellent entertainment possibilities.

Conditions for Successful Television

Just what are some of the requirements essential to good radiovision reception?

In the first place, it is essential to pick up clean, powerful, well-modulated signals. There are several television transmitters on the air today, serving a considerable portion of the country. Two Jenkins television stations, for instance, are broadcasting satisfactory signals over a considerable area for television experimenters and those provided with commercial "radiovisors."

One station, W3NK, is located some six miles north of Washington in Montgomery County, Md., and operates on a frequency of 2,900 kilocycles, which is equivalent to 103 meters. The other station, W2NCR, is located on the roof of the Jenkins plant in Jersey City, N. J., and operates on a newly-assigned frequency of 2,800 kilocycles, or 107 meters. Both stations are licensed for an output up to 5 kilowatts.

Although the usual "service range" of these stations is conservatively limited to 100 miles, the signals are being received and "radiovised" as far as Chicago and even to

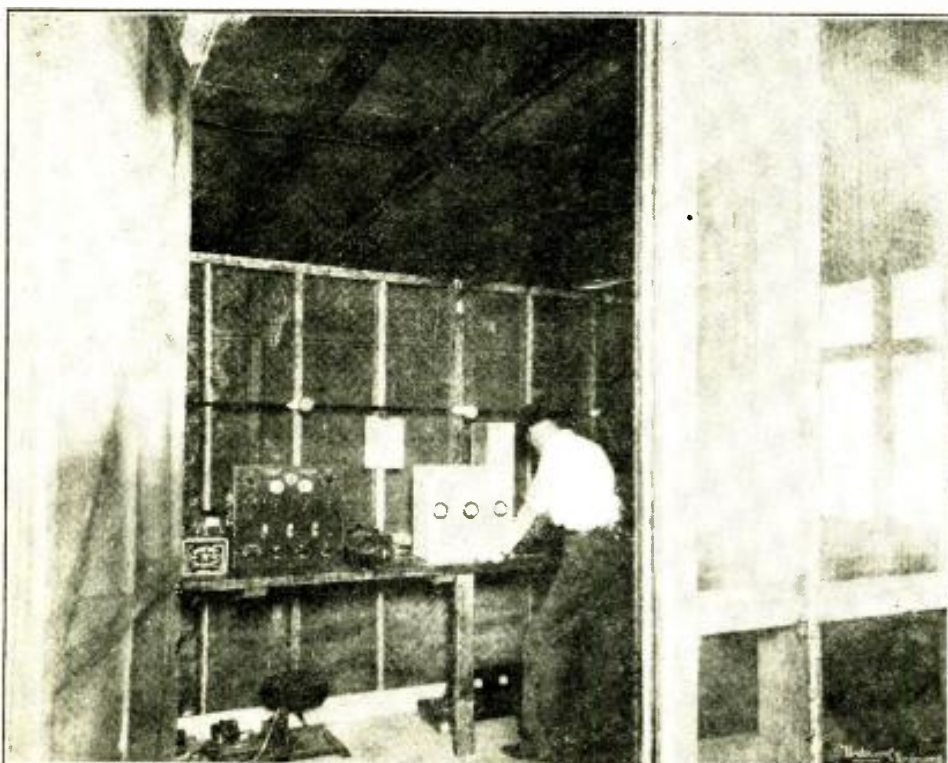

The "studio" of Station W2NCR, the television broadcast transmitter of the Jenkins Television Corporation, is completely encased in grounded copper screening to prevent stray electrical interference from getting into the amplifier input and affecting the signals.

© Underwood & Underwood

Iowa, in one direction, and up through New England as far as Boston.

Sensitivity A Factor in Pictures

It should be noted that a high signal strength is required for good radiovision reception, as contrasted with the requirements of sound broadcast reception. Whereas a "sound" signal may be of sufficient strength if it can be heard even by headphones, in the case of radiovision the signal strength must be ample for loud-speaker volume to fill the average room, and even be heard in the adjoining room. Unless there is so much signal strength available, it will be quite impossible to modulate the neon glow-lamp. *The starting point of many television failures is insufficient signal strength.*

One of the problems is a receiver that is too sensitive. In other words, we are more

troubled with inductive interference, or so-called "man-made static," in radiovision than in sound broadcasting. Consequently, the highest possible "signal level" is necessary. (The subject of "signal level" and "background noise" was discussed in the first part of the article, "Causes and Cure of Radio Interference," by F. R. Bristow, which appeared in the January, 1930, issue of RADIO-CRAFT magazine.—Editor.)

In sound broadcasting, "background noise" can be tolerated; and it may even pass unnoticed because of the subject interest of the program, which takes the listener's mind away from extraneous noise. In sight broadcasting, however, the eye cannot help detecting any blemish in the pictorial pattern.

(It may be here pointed out that a problem not encountered in "sound" reception, but one with which the "visual" engineer

must contend, is static interference, causing picture distortion, on frequencies outside of the standard 10-ke. broadcast audio band but within the 20- to 30-ke. picture band.—Editor.)

Fortunately, intermittent inductive interference, such as that from an oil burner or electric sign flasher, is not as annoying as in sound broadcasting. It simply causes a spot or streak to appear at intervals, and may hardly be noticed. *Steady interference*, such as that from a sparking motor, however, causes the appearance of a permanent blemish which interferes with the enjoyment of the radiovision program.

It follows that the sensitivity of the radiovision receiver should not be great unless the looker-in lives at a considerable distance from the television transmitter and is fam-

(Continued on page 475)

The Inventor and His Patent

By J. HAROLD BYERS

IS there an experimenter who has not thought of himself as an inventor, or who has not speculated on the possibilities of patenting some idea that would win him fame and fortune? The answer is in the negative.

This article was prepared by the writer, a former examiner in the U. S. Patent Office at Washington, to answer many of the first questions which will occur to everyone's mind regarding the cost and the scope of a patent and, incidentally, to give a better idea of the rate at which the inventive brains of America are working. Many readers of RADIO-CRAFT have undoubtedly wished for the authentic information given here; which, though in many cases approximate, is reliable for practical purposes.

The authorities for the following statements, when available, and the methods of arriving at the conclusions, are explained here:

What does a patent cost?

Concise and comprehensive reports on this subject are not abundant. Unquestionably, a patent can be obtained for less than 200 dollars; it is believed, however, that this is a reasonable figure for competent legal services where an invention of moderate complexity is concerned. (Some attorneys do not charge for amendments.) The list below enumerates the separate items of cost:

Search of the art	\$10
Government filing fee	20
Legal services in the preparation and filing of:	
the petition	
the specification	
the claims	
the oath	
the drawing	100
Amendments	50
Final Government fee	20
Total	\$200

The approximate average cost of the amendments is obtained by taking 20 dollars as the cost of one amendment and multiplying it by the average number of amendments; which is, approximately, 2.5. The source of this figure is explained in a note at the end of this article.

D. B. Keyes in *Chemical and Metallurgical Engineering* for Sept. 3, 1923, gives an estimate of the cost of a patent that is surprisingly high: "It has been found that approximately \$500 is a fair average for the cost of a United States patent." The article does not explain how the figure \$500 was ascertained.

Mr. Keyes, in an article appearing Oct. 15, 1923 in the same journal, gives approximate estimates of the average total costs of patents in foreign countries as follows:

Country	Cost
United States	\$ 500
England	870
France	710
Germany	1,510
Norway	510

How long does it take to get a patent?

Again it is desired to point out that there is nothing prophetic about these figures; there is no guarantee attached to them. The figure 4½, applied to the number of years it takes to get a patent, means simply that the respective times for a number of instances have been added and divided by the number. It does not mean that the time it will take *you* to get a patent will coincide with that quotient.

A statement, ascribed to Senator King, is quoted from the *Washington Post* for April 22, 1929: "—two to seven years are required for the granting of a patent." Averaging Senator King's estimates, we arrive at the figure 4½.

(Continued on page 477)



A view of the Patent Office at Washington, a building more than a century old, showing at right and left a few of the alcoves which house the 120 miles of shelves full of patents.

© Underwood & Underwood

Amplifying the Television Signal

Principles of design essential in the construction of an amplifier capable of faithful amplification of super-audible frequencies, and the constants of such a unit

By C. H. W. NASON

Engineering Department, Jenkins Television Corp.

ALTHOUGH utilized in widely divergent services, the television signal differs but slightly from that of radio telephony. In broadcasting, the radio-frequency carrier is modulated at an audible rate corresponding to the signal input to the modulator tube. The modulation voltages are composites of frequen-

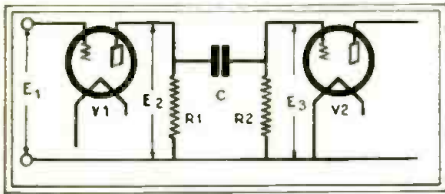

Fig. 1

The problem in designing an amplifier is to keep the ratio of the input voltage E3 to the output voltage E2 as high and constant as possible.

cies varying from about 50 to slightly beyond 5000 cycles. In television, the signal components cover a band of frequencies, ranging from as low as 15 cycles on through the entire audible range and beyond. The highest frequencies to be encountered, in the present state of the art, are of the order of 30,000 cycles. Obviously, the audio-frequency amplifiers of standard design are unsuitable in such a case; and a special problem in amplifier design confronts the worker entering the television field.

It is a wise, though not universally accepted, practice in the design of apparatus of a multiple character, to consider each unit as an entity and to strive for perfection in the design of that single element of the whole, without regard for the failings of the associated apparatus.

According to our previous statement regarding the frequency-band utilized, we see that our amplifier must present a gain-frequency characteristic essentially flat from 15 cycles to 30 kilocycles (Fig. 4.) The inability of the eye to differentiate between small variations in light intensity, without a standard of comparison in direct juxtaposition, makes allowable a deviation from normal gain of plus or minus twenty per cent. over the band.

Resistance Coupling Essential

The high-frequency response of any amplifier is dependent upon the admittances due to shunt or stray capacities remaining negligibly low in comparison with those of the other circuit elements. The inherent stray capacities of transformer windings make it impossible to design a transformer-coupled amplifier capable of reaching both the low and the high frequencies. The same disadvantage is present in impedance-coupled circuits. Hence, we are limited to resistance coupling in one form or another; not because of the effects of stray capacities, but because of the variation in phase displacement apparent in trans-

former-coupled circuits, with variation of the signal frequency. The human ear is incapable of recognizing phase differences; but phase distortion of the television signal is quite apparent in the received image, and quite apart from discrimination against the higher frequencies. The transformer-coupled amplifier is therefore unsuited for television use.

In a resistance-capacity-coupled amplifier (shown schematically in Fig. 1) the basic gain per stage is a "function" of the "mu" (μ) of the tube V1, the plate resistance Rp, and the load resistance R3. That is, at a mid-range frequency where the reactance of C is negligible and with the effective load resistance taken as the paralleled grid- and plate-resistance values,

$$\text{or } R3 = \frac{R1 R2}{R1 + R2}$$

The gain per stage is:

$$\frac{E2}{E1} = \mu \frac{R3}{R3 + Rp}$$

This we may consider as a constant from

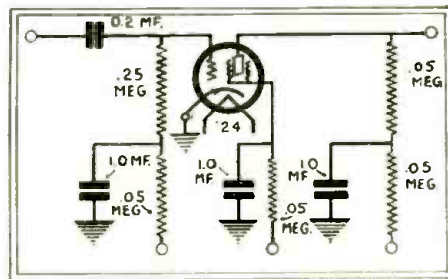

Fig. 2

The fundamental circuit of the improved Jenkins television amplifier. With grid-leak detection, an odd number of stages is used; with power detection, an even number.

which all deviations from the normal gain are to be measured; taking it as 100%, the percentage of reproduction attained at other frequencies is

$$\frac{E3/E2}{E3/E2} \times 100$$

Inspection of the equation shows that the gain is primarily dependent upon the magnitude of R3; and that the condition

$E2/E1 = \mu \frac{R3}{R3 + Rp}$ approaches unity, through the

plate resistance's becoming negligibly small in comparison with the load resistance.

It is possible that, at some low frequency, the reactance of C will become large in comparison with R2; and an attendant rise in R3 will increase the gain at the low-frequency end. This is usually overcome, through the fact that E3 is taken across R2 in series with the reactance.

In computing the response at the low frequencies we have

$$\frac{E3}{E2} = \frac{R2}{\sqrt{R2^2 + XC^2}} = \frac{\omega R2 C}{\sqrt{\omega^2 C^2 R2^2 - 1}}$$

The evaluation of the quantity is dependent upon the factor C R2 and, with a predetermined value of R2, the low-frequency response is dependent upon the value of C. Likewise, with a fixed value of C, raising the value of R2 will improve the amplification at the low end.

C R is the "time constant"; numerically equivalent whether C and R are taken in farads and ohms, or in megohms and microfarads. Its values for a reproduction factor of 95%, at various low frequencies, are as follows:

Frequency	T
10 cycles	.05
20 "	.025
50 "	.01
95 "	.005
190 "	.0025

The reproduction factor must be held high in the individual stage; as the percentage of amplification at a given frequency decreases geometrically with the number of stages. Thus a reproduction factor of 95 in the single stage becomes 85.7%, when cubed by three successive stages.

Effect of Tube Capacities

The high-frequency response is less subject to predetermination. Obviously, as the value of the grid-filament capacity reactance (Continued on page 457)

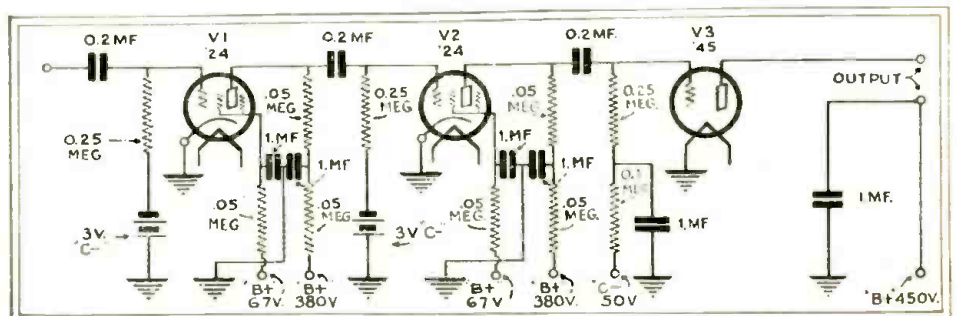

Fig. 3

The complete circuit of the new Jenkins television amplifier, whose characteristic is practically flat up to 30,000 cycles. Constants are given in the diagram; the high degree of filtering and circuit isolation shown is absolutely essential.

Modern Sound Projection

(PART II)

There is "money in sound projection," but there are also fundamentals to be mastered. In this installment a practical sound projectionist clearly describes just what are these fundamentals.

By RICHARD CARMAN

THE main purpose of the "Sound" projection equipment is to reproduce speech, music or incidental sounds in connection with moving pictures, in so realistic a manner that the effect is practically equivalent to having the speakers or artists actually present; every sound should be heard at the same moment that the action accompanying it is seen on the screen. A further use is to accompany feature pictures with specially-recorded "cued" music and appropriate sound effects, known as "synchronized score"; so that every scene shall have music and sound effects appropriate to the action and, when the scene changes, any corresponding change in the character of the sound accompaniment shall be made accurately and automatically at the precise moment. Hence, the two applications mentioned above are collectively called synchronous reproduction.

Disc Reproduction

Of the many possible ways of recording and reproducing sound, there are but two which have been accepted for the use of sound projection. The disc method utilizes a disc similar to a phonograph record, but larger and of a higher type. (See Fig. A). These records are made originally at the studios on discs, technically known as "the wax." From these "wax" discs are made more permanent records. The desired sound

THE "talkies" and their kindred developments, all originating from the application of radio engineering methods to the moving-picture and the phonograph industries, present a wonderful opening to the radio technician. The ambitious radio Service Man and experimenter should not fail to read every one of this series of articles on Sound Projection which began in the February issue of RADIO-CRAFT
—Editor.

recorded on them is separated from those which are undesired; and there is made another record containing only the desired sound, which matches perfectly the film with which it is to be used. This record is then forwarded to some large record manufacturer (such as Victor or Columbia) by whom the records actually used in projection in the theaters are made. The records are played twenty to forty times, and an accurate log of the number of times played is kept on each record itself. By limiting the number, the quality of the sound is maintained at a high standard.

Another consideration in the use of the records is the choice of needles. Regular phonograph needles are employed; the size used being dependent on the type of sound

and whether it is of an even texture, such as soft music, or whether it is of a harsh variety. If the sound recorded is of a character where the sound is sudden—such as a shot, or a door slam, or war scenes—a low-tone needle (long and thin) is used; because it is less likely to break down the walls of the grooves, thus causing the needle to "single-track" or jump. Where there is no danger of sudden noises, and where the best quality is desired, a full-tone needle is used. A low-tone needle or a half-tone needle is less likely, however, to jump or single-track.

To keep the record running at an absolutely even rate of speed, a device known as a mechanical filter is employed. No matter how accurately the machinery running the record turntable has been made, there will be a certain unevenness or fluttering of the reproduced sound if the filter is not used. The method is that of connecting the turntable to the driving shaft through a series of springs so mounted that they absorb any mechanical vibration or flutter. These springs are sometimes augmented by a "hydraulic" arrangement of baffle plates and oil.

Film Sound Reproduction

The film method (See Fig. B) consists of a sound-track on the side of standard film, approximately 1/10th of an inch in width, upon which is made a photographic record of the sound. There are at present two types of this sound-on-film: both employ the same sound-track or band; but on one the sound vibrations are recorded as alternate light and dark lines of varying density; while in the other the variations are recorded by dividing the band into black and white portions. In the latter, the black portion varies in proportion to the sound vibrations and its edge has an appearance similar to that of mountains, or a jagged and irregular line. In the projector these variegated lines serve as means for varying the amount of light which is thrown from the focused image of the filament of the exciter lamp into the photoelectric cell. The exciter lamp is a straight-line-filament bulb, usually operating on 12 volts and drawing approximately 4 amperes. This filament lights to a very high brilliancy, and its illumination is focused by a system of tiny lenses, so that a tiny, fine line of light falls upon the sound-track of the film. The photoelectric cell is placed in the optical track of the exciter lamp, lens and film; and these in combination with the necessary sprockets, idlers and mechanical filter (used in this case on the sprocket immediately beyond the point where the "sound-aperture" is placed) compose what is called the film pick-up head.

Two or more sound projectors are usually installed in the booth. In some cases, these

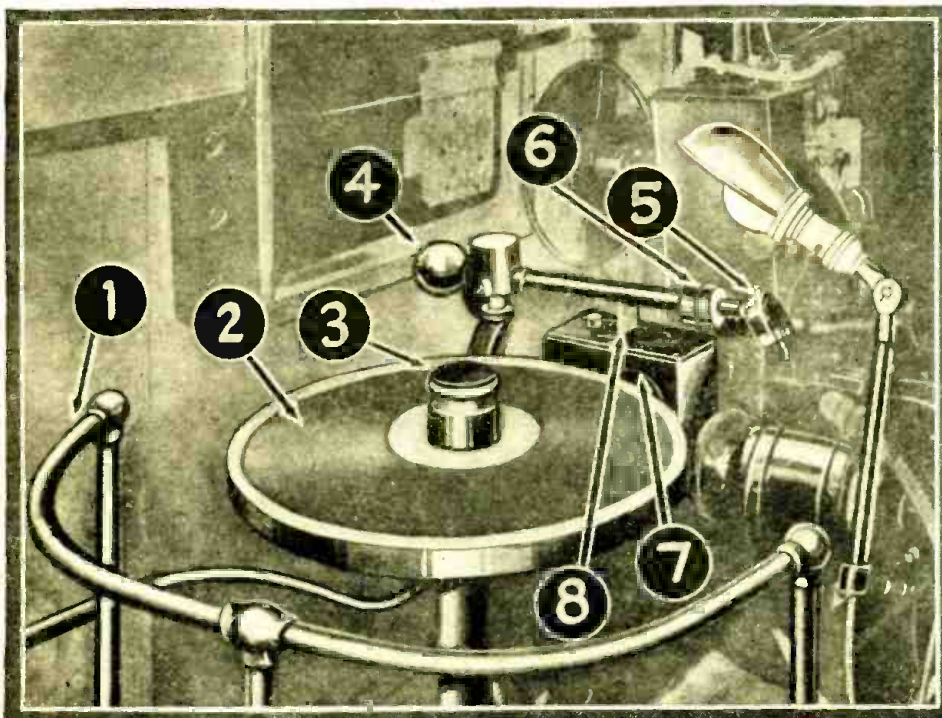

Fig. A

"Sound-on-Record" components: 1, guard rail; 2, turntable (technically referred to as the "platter"), upon which is seen a record; 3, retaining cap, heavily weighted; 4, counterweight; 5, pick-up; 6, vernier counterweight; 7, coupling gear-box; 8, pick-up rest.

Short-Wave Stations of the World

Meters	Kilo-cycles	Call Letters / Station Name	Program / Notes
4.97-5.35	60,000-50,000	Amateur Telephony.	
8.57	35,000	W2XCU, Amberg, N. J.	
12.48	21,000	W6AQ, San Mateo, Calif.	Several experimental stations are authorized to operate on non-exclusive waves of a series, both above this and down to 1 meter.)
13.04	23,000	W2XAW, Schenectady, N. Y.	
13.97	21,400	W2XAL, New York.	
14.06	21,329	DIV, Nauen, Germany.	
14.50	20,680	LSH, Monte Grande, Argentina, after 10:30 p.m. Telephony with Europe.	
		FMB, Tamatave, Madagascar.	
		PMB, Bandung, Java.	
14.62	20,500	W9XF, Chicago, Ill. (WENR).	
14.81	20,200	DGW, Nauen, Germany, 2 to 9 p.m. Telephony to Buenos Aires.	
16.03	19,950	LSG, Monte Grande, Argentina, From 9 a.m. to 1 p.m. Telephony to Paris and Nauen (Berlin).	
		DIH, Nauen, Germany.	
15.10	19,850	WMI, Deal, N. J.	
15.10	19,460	FZU, Tamatave, Madagascar.	
15.50	19,350	Nancy, France, 1 to 5 p.m.	
		FW3, Paris, France, From 10 a.m. Telephony to Monte Grande (Buenos Aires).	
		VK2ME, Sydney, Australia.	
15.60	19,229	WNC, Deal, N. J.	
15.85	18,929	XDA, Mexico City, Mex. 12:30 to 2:30 p.m.	
15.91	18,850	PLE, Bandung, Java, Broadcasts Wed. 8:40 to 10:40 a.m. Telephony with Kootwijk (Amsterdam).	
16.10	18,620	GBJ, Bodinn, England, Telephony with Montreal.	
16.11	18,610	GBU, Rugby, England.	
16.30	18,100	PCK, Kootwijk, Holland. Daily from 1 to 6:30 a.m.	
16.35	18,350	WND, Deal Beach, N. J. Transatlantic telephony.	
16.38	18,310	GBS, Rugby, England, Telephony with New York. General Postoffice, London.	
16.50	18,170	CGA, Drummondville, Quebec, Canada. Telephony to England. Canadian Marconi Co.	
16.51	18,130	GBW, Rugby, England.	
16.57	18,120	GBK, Rugby, England.	
16.61	18,050	KQJ, Boston, Calif.	
16.70	17,950	FZU, Tamatave, Madagascar.	
16.80	17,850	PLF, Banoenc, Java ("Radio Malabar"). Works with Holland.	
16.82	17,820	PCV, Kootwijk, Holland, 3 to 9 a.m.	
16.88	17,770	PHI, Huizen, Holland, Beam station to Dutch colonies. Broadcasts Mon., Wed., Thurs., Fri. 8 to 11 a.m. N. V. Phillips Radio, Amsterdam.	
16.90	17,750	HSIPJ, Bangkok, Siam, 7-9:30 a.m., 1-3 p.m. Sundays.	
17.20	17,440	AGC, Nauen, Germany.	
17.51	17,300	W2XK, Schenectady, N. Y. Tues., Thurs., Sat., 12 to 5 p.m. General Electric Co.	
		W2XCU, Amberg, N. J.	
		W9XL, Anoka, Minn., and other experimental stations.	
18.10	16,300	PCL, Kootwijk, Holland, Works with Holland from 7 a.m. Netherland State Telegraphs.	
		WLO, Lawrence, N. J.	
18.56	16,150	GBX, Rugby, England.	
18.75	15,900	Saigon, Indo-China.	
18.80	15,950	PLG, Bandung, Java, Afternoons.	
19.55	15,310	W2XA, Schenectady, N. Y. Broadcasts Sun., 2:30 to 5:40 p.m.; Tues., Thurs. and Sat. noon to 5 p.m.; Fri. 2 to 3 p.m.; besides relaying WGY's evening program on Mon., Wed., Fri. and Sat. evenings. General Electric Company.	
19.60	15,200	Lyngby, Denmark, Experimental.	
19.67	15,250	W2XE, New York, N. Y.	
19.69	15,250	W2XAL, New York, N. Y.	
19.70	15,220	W9XF (KDKA), Pittsburgh, Pa. 4:30 p.m. on Saturdays from 6. Sundays, entire program.	
19.99	15,000	CM6XJ, Central Tulmen, Cuba. (L.S.), Monte Grande, Argentina.	
20.00	14,900	TZSH, Uelinge, N. Y.	
20.30	14,420	VPD, Suva, Fiji Islands.	
20.90	14,140	G2NM, Caterham, England.	
20.97-21.26	14,000-14,000	Amateur Telephony.	
22.20	13,500	Vienna, Austria.	
22.28	13,100	WND, Deal Beach, N. J. Transatlantic telephony.	
22.69	13,050	W2XAA, Houlton, Me. Transatlantic telephony.	
22.75	13,180	WFA, Byrd Expedition, Antarctica.	
		WFAT, S. S. "Eleanor Bolling," Byrd Expedition.	
23.35	12,850	W2XU, Schenectady, N. Y. Antipodal program 9 p.m. Mon. to 3 a.m. Tues.; noon to 1 p.m. on Tues., Thurs. and Sat. General Electric Co.	
		W6KN, Oakland, Calif. Relays KGO from 8 p.m., Mon., Thu., Sat., to 2:40 a.m. Tues., 3 a.m. Fri., 4 a.m. Sunday. General Electric Co.	
		W2XCU, Amberg, N. J.	
		W9XL, Anoka, Minn., and other experimental relay broadcasts.	
24.41	12,280	GBU, Rugby, England.	
24.50	12,210	FW4, Ste. Assise (Paris) France, Works Buenos Aires, Indo-China and Java. On 9 a.m. to 1 p.m. and other hours.	
		KXBR, Manila, P. I.	
		GBX, Rugby, England.	
24.93	12,180	Airplane.	
24.98	12,150	GBS, Rugby, England, Transatlantic phone to Deal, N. J. (New York).	
24.99	12,045	NAA, Arlington, Va. Time signals, 8:55-9 a.m., 9:55-10 p.m.	
24.98	12,000	FZG, Saigon, Indo-China. Time Signals, 2-2:05 p.m.	
25.10	11,915	KKQ, Buhas, Calif.	
25.10	11,910	Zeesen, Germany, Tests of new Super-heretzer broadcasts.	
25.31	11,810	W2XE, Jamaica, New York (WABC).	

All Schedules Eastern Standard Time: Add 5 Hours for Greenwich Mean Time.

Meters	Kilo-cycles	Call Letters / Station Name	Program / Notes
25.49	11,800	W8XK (KDKA) Pittsburgh, Pa. 4:30 p.m. on Saturdays from 6 on; Sundays entire program.	
		W9XF, Chicago (WENR).	
		W2XAL, New York (WKNY).	
25.53	11,750	GSSW, Chelmsford, England, 7:30-8:30 a.m. and 2-7 p.m. except Saturdays and Sundays. Also 7-9 p.m. Mondays and Wednesdays. Tests with W2XO 12-1 a.m. Mondays and Thursdays.	
25.60	11,710	CJRX, Winnipeg, Canada, 5:30 to 8 p.m. daily, Sun. 1 to 2 p.m. Relays CJRW. James Richardson & Sons, Ltd.	
25.68	11,670	KIO, Kahala, Hawaii.	
26.00	11,530	CGA, Drummondville, Canada.	
26.10	11,490	GBK, Rugby, England.	
26.22	11,430	DHC, Nauen, Germany (Berlin) Weekdays after 5, Sun after 9 p.m.	
		DHF, Nauen, Germany.	
26.70	11,250	WSBN, S.S. "Leviathan" and A. T. & T. telephone connection.	
27.00	11,100	EATH, Vienna, Austria, Mon. and Thurs., 7 to 8 p.m.	
27.75	10,800	PLN, Bandung, Java.	
27.88	10,760	PLR, Bandung, Java, Works with Holland and France weekdays from 7 a.m.; sometimes after 9:30.	
28.00	10,710	VAS, Glouce Bay, N. S., Canada 6 a.m. to 2 p.m. Canadian Marconi Co.	
28.50	10,510	RDRL, Leningrad, U.S.S.R. (Russia)	
		VK2BL, Sydney, Australia.	
28.80	10,410	ZMB, Sydney, Australia, Irregular. On Wed. after 6 a.m. Amalgamated Wireless of Australia, Pennant Hills, N. S. W.	
		KES, Bolinas, Calif.	

(NOTE: This list is compiled from many sources, all of which are not in agreement, and which show greater or less discrepancies in view of the fact that most schedules and many wavelengths are still in an experimental stage; that daylight time introduces confusion and that wavelengths are calculated differently in many schedules. In addition to this, one experimental station may operate on any of several wavelengths which are assigned to a group of stations in common. We shall be glad to receive later and more accurate information from broadcasters and other transmitting organizations, and from listeners who have authentic information as to calls, exact wavelengths and schedules. We cannot undertake to answer readers who inquire as to the identity of unknown stations heard, as that is a matter of guesswork; in addition to this, the harmonics of many local long-wave stations can be heard in a short-wave receiver.—EDITOR.)

29.50	10,150	ARI, Hongkong, China, 8 a.m.
29.98	10,000	CM2LA, Havana, Cuba.
30.00	9,950	Paris, France, Radio de Paris, Apartado 40.
30.15	9,940	GBU, Rugby, England.
30.20	9,930	W2XU, Long Island City, New York.
30.41	9,790	GBW, Rugby, England.
30.75	9,750	Aeon, France, Tues. and Fri., 5 to 6:15 p.m.
30.80	9,700	NRH, Heredia, Costa Rica, 10:00 to 11:00 p.m.
31.00	9,680	TLO, Natal, Kenya, Africa, Noon to 2 p.m. Relays G2SW, Chelmsford, frequently from 2 to 5 p.m.
		Monte Grande, Argentina, works Nauen irregularly after 10:30 p.m.
31.25	9,690	LBN, Bergen, Norway.
31.26	9,500	PCJ, Hilversum, Holland, Wed. 8-10 p.m.; Thurs., Fri., 7-11 p.m.; Fri. 2-4 p.m., 8 p.m. to 2 a.m. Sat., N. V. Philips Radio, Eindhoven, Holland.
31.28	9,580	VK2FC, Sydney, Australia, Irregularly after 1 a.m. N. S. W. Broadcasting Co.
		VPD, Suva, Fiji Islands.
31.35	9,570	WIXAZ, Springfield, Mass. (WBZ).
31.39	9,530	Paris, France, Radio de Paris, Apartado 40.
31.18	9,520	W2XAF, Schenectady, New York, Minn., Tues., Thurs. and Sat. nights, relays WGY from 6 p.m. General Electric Co.
		W9XA, Denver, Colorado, Relays KOA.
		Helsingfors, Finland.
31.50	9,500	VK3LO, Melbourne, Australia, Irregular. Relaying on air.
		OZTRL, Copenhagen, Denmark, Around 7 p.m.
31.90	9,450	Langby, Denmark.
31.05	9,430	Paris, France, 4 p.m. weekdays.
31.80	9,430	Poznan, Poland, Tuesdays and Saturdays, 1:50-1:30 p.m. Sat., 1:25-7 p.m.
32.00	9,375	THDC, Geneva, Switzerland, Mon., Tues., Sat. to 1 p.m.
		OZMKK, Copenhagen, Denmark, Irregular after 7 p.m.
32.06	9,350	CM2MK, Havana, Cuba.
32.13	9,330	CGA, Drummondville, Canada.
32.10	9,250	GBK, Rugby, England.
32.54	9,250	Paris, France, Eiffel Tower) Time Signals, 9:59 a.m. and 1:50 p.m.
		VK2BL, Sydney, Australia.
32.50	9,200	GBS, Rugby, England, Transatlantic phone.
33.26	9,010	GBS, Rugby, England.
33.70	8,900	Poznan, Poland, Tests Mon. and Thurs., 8 to 7 p.m.
33.81	8,872	NPO, Carite (Manila) Philippine Islands, Time signals 9:55-10 p.m.

Meters	Kilo-cycles	Call Letters / Station Name	Program / Notes
33.96	8,830	WFAT, S. S. "Eleanor Bolling," Byrd Expedition.	
34.03	8,810	WFA, Byrd Expedition, Antarctica.	
34.50	8,690	W2XAC, Schenectady, New York.	
34.68	8,650	W2XCU, Amberg, N. J.;—W9XL, Chicago.	
34.71	8,630	WDO, Deal, N. J.	
35.00	8,570	HKJC, Manizales, Colombia.	
35.93	8,560	KVUA, S. S. "Lake Ormeo," Ford Motor Co.	
35.48	8,450	WSBN, S.S. "Leviathan."	
36.00	8,330	3KAA, Leningrad, Russia, 2-6 a.m., Mon., Tues., Thurs., Fri.	
37.02	8,100	EATH, Vienna, Austria, Mon. and Thurs., 5:30 to 7 p.m.	
		HS4P, Bangkok, Siam, Tues. and Fri., 8-11 a.m., 2-4 p.m. Tuesdays.	
37.36	8,030	NAA, Arlington, Va. Time signals 8:55-9 a.m., 9:55-10 p.m.	
37.43	8,015	Airplanes.	
37.80	7,930	DDA, Doberitz, Germany, 1 to 3 p.m. Radio postcentralamt, Berlin.	
38.00	7,890	VPD, Suva, Fiji Islands.	
38.30	7,830	PCV, Kootwijk, Holland, after 3 a.m.	
38.56	7,775	FBBZ, Montelimar, France.	
38.80	7,770	PCL, Kootwijk, Holland, 9 a.m. to 7 p.m.	
39.98	7,590	TFZSH, Reykjavik, Iceland.	
		EK4ZZZ, Danzig (Free State).	
40.20	7,460	YR, Lyons, France, Daily except Sun., 11:30 a.m. to 12:30 p.m.	
41.00	7,310	Paris, France, ("Radio Vitus") Tests.	
41.46	7,230	DDA, Doberitz, Germany.	
41.50	7,200	Zurich, Switzerland, Sat. 3 to 5 p.m.	
41.70	7,190	VK6AG, Perth, West Australia, Between 6:30 and 11 a.m.	
42.12	7,120	OZTRL, Copenhagen, Denmark, Irregular. Around 7 p.m.	
42.27	7,030	PMZ, All-American Lyric Expedition, Toronto.	
43.00	6,870	EAR 110, Madrid, Spain, Tues. and Sat., 5:30 to 7 p.m.	
43.50	6,800	IMA, Rome, Italy, Sun., noon to 2:30 p.m.	
43.57	6,800	D4AFF, Coethen, Germany.	
43.86	6,835	VRY, Georgetown, British Guiana, Wed. and Sun., 7:45 to 10:15.	
44.00	6,820	XC 51, San Lazaro, Mexico, 3 a.m. and 5 p.m.	
45.00	6,800	Berlin, Germany.	
45.20	6,835	WSBN, S.S. "Leviathan."	
45.56	6,830	WFA, Byrd Expedition, Antarctica.	
		WFAT, S. S. "Klemm Bolling."	
46.05	6,515	WDO, Deal, N. J.	
46.76	6,425	W2XCU, Amberg, N. J.;—W9XL, Anoka, Minn., and others.	
47.00	6,380	CT3AG, Funchal, Madeira Island, Sat. after 10 p.m.	
47.21	6,350	Airplanes.	
47.35	6,235	W10XZ, Airplane Television.	
48.74	6,155	W9XAL, Chicago, Ill. (WMAC) and Airplanes.	
48.80	6,140	KIXR, Manila, P. I., 3-4:30, 5-9 or 10 a.m., 2-3 a.m. Sundays.	
48.90	6,120	Motala, Sweden, "Rundradio," 6:30-7 a.m., 11-1:30 p.m., Holidays, 5 a.m.-5 p.m.	
		ARI, Hongkong, China.	
49.02	6,120	W2XE, New York City, Relays WABC. Atlantic Broadcasting Co.	
49.15	6,100	W3XL, Bound Brook, N. J. (WJZ, New York), 12 midnight on.	
49.20	6,040	W2XAL, New York.	
49.31	6,050	W2XGX, Newark, N. J. Relays WOL.	
		W9XAA, Chicago, Ill. (WCFL).	
49.40	6,070	UORZ, Vienna, Austria, 5-7 a.m., 5-7 p.m.	
49.50	6,060	W8XAL, Cincinnati, Ohio, Relays WJW.	
49.67	6,040	W9XAO, Chicago, Ill. (WMAV).	
49.80	6,020	W9XF, Chicago, Ill.	
		W2XBR, New York, N. Y. (WENY).	
49.95	6,000	213ZC, Christchurch, New Zealand, 11 p.m. midnight.	
		EJAZS, Barcelona, Spain, Sat. 3 to 4 p.m.	
		RFN, Moscow, Russia, Tues., Thurs., Sat. 8 to 9 a.m.	
		SAJ, Karlsborg, Sweden.	
		Eiffel Tower, Paris, France Testing 6:30 to 6:45 a.m., 1:15 to 1:30, 5:15 to 5:45 p.m., around this wave.	
51.00	5,880	Technigaph, Honolulu, 9:15 p.m.-midnight, Mon., Wed., Fridays.	
52.00	5,770	AFL, Bergholtz, Germany.	
52.72-54.41	5,690-5,510	Aeroplan.	
44.51	5,600	W2XBB, Brooklyn, New York City (WRBC, WGBH).	
60.70	5,300	AGJ, Nauen, Germany, Occasionally after 7 p.m.	
58.00	5,172	Prague, Czechoslovakia.	
60.90	5,120	LL, Paris, France.	
61.22	62.50	buffers 4,800 to 4,900 kc. Television.	
		W8XK, Pittsburgh, Pa.;—W1XAY, Lexington, Mass.; W2XBU, Beacon, N. Y.;—WENR, Chicago, Ill.	
62.50	4,800	W8XK, Pittsburgh, Pa. Relays KDKA after 6 p.m. Works with 5W 5 to 7 p.m. Tues. and Thurs. Westinghouse Electric Co.	
62.56	4,795	W9XAM, Berlin, Ill.	
		W9XL, Chicago, Ill.	
62.69	4,685	Aircraft.	
63.22	4,697	meters 4,500 to 4,600 kc. Television.	
		W6XC, Los Angeles, Calif.	
67.65	4,430	DDA, Doberitz, Germany, 6 to 7 p.m., 3-4 p.m. Mon., Wed., Fri.	
70.00	4,280	OHK2, Vienna, Austria, Sun., first 15 minutes of hour from 1 to 7 a.m.	
		RA97, Khatynsk, Siberia, 5:29-7 a.m.	
71.77-72.98	4,150-4,100	Aircraft.	
72.87	4,110	WDO, Deal, N. J.	
73.72	4,065	NAA, Arlington, Va. Time signals 8:55-9 a.m., 9:55-10 p.m.	
80.00	3,750	FBR, Constantinople, Tunis, Africa, Mon. and Fri.	
84.21	3,560	OZTRL, Copenhagen, Denmark, Tuesday and Fri. after 6 p.m.	
84.46-85.66	3,550-3,500	Amateur Telephony.	
86.50-86.09	3,490-3,360	Aircraft.	

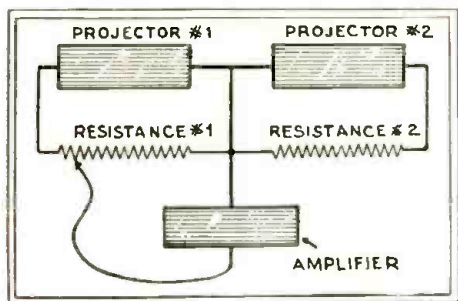

Fig. 4

Simplified circuit of the fader: resistances 1 and 2 are the two halves of a center-tapped potentiometer. Projectors 1 and 2 represent the sound pick-up devices, not the reproducers.

projectors are equipped for only one type of sound reproduction; namely, film or disc. It is more common, however, to find the projectors equipped for sound on film and disc as well; because of the fact that neither type has gained sufficient prestige over the other to make it universally used by all the producers. So, in order to play any picture desired, they must be thus doubly equipped.

Synchronization Methods

In ordinary moving-picture projection, the film was usually shown at a faster speed than that at which it was taken. However, the old motors with their speed controls and clutches have been discarded; because the speed at which sound pictures are shown must be identical with that at which they were taken—which has been standardized to 90 feet per minute in standard 35-millimeter film (1.38 inches wide). This speed must be maintained exactly; otherwise, the pitch of all sounds would be changed, and this would cause the voice or music to be distorted and spoiled. The speed is maintained automatically by either a compound-wound motor on direct current, or a synchronous motor on alternating current; since these are constant-speed machines. Some types of installation utilize a special type of motor in conjunction with a tuned circuit in a motor-control box placed alongside of the machines.

Before describing the operation of the motor-control box, it is necessary to explain that its operation depends on the principle of the tuned or resonant circuit. This, as all radio men know, means a circuit which will permit alternating current of a certain frequency to pass quite readily, but which offers a high resistance to alternating currents of any other frequencies. The frequency which such a circuit is designed to pass is called the resonant or critical frequency.

Now, in electrical engineering, a choke coil or inductance has the same effect on an electrical circuit that a weight (or more properly a mass, such as a flywheel) has on a mechanical device; and a condenser plays the same part electrically that a spring or other elastic member does mechanically. Since alternating current is nothing but a back-and-forth movement of electricity in a circuit, it is possible, by using a circuit consisting of a choke coil and a condenser, to create resonance effects.

In providing speed control for the motor, the first thing necessary is to have some means by which the motor can, so to speak, signal to the control box to show at what

speed it is running. This is done by building into the motor a small A.C. generator, on the same shaft and within the same housing. This generator produces alternating current whenever the motor is running; and the frequency of this alternating current will always be in exact proportion to the speed of the motor at that moment. Thus the A.C. generator acts as a pilot or speed indicator.

When the motor is running at the standard speed, the generator is producing an alternating current of a certain frequency which changes at the slightest variation in speed. In Western Electric Equipment the standard speed of the generator is 1200 R.P.M. and, at this speed, it delivers A.C. current with a frequency of exactly, 720 cycles (per second). Since the critical frequency of the tuned circuit in the motor-control box is also 720 cycles per second—it will readily pass A.C. at this frequency but not at any other; and here lies the key to the whole action of this apparatus.

During the period just after the power has been put on the motor, when it is picking up speed, the generator frequency will be below 720 cycles; therefore no current will pass through the tuned circuit and the

motor is free to speed up in the ordinary manner. When the motor reaches its standard speed of 1200 R.P.M., the generator also comes up to the 720 cycles; and then current passes through the tuned circuit, which comes into action and affects the control circuit of the motor, preventing any further increase in speed. This action will now be explained in further detail.

The motor used on D.C. supply is a compound-wound motor of the regular type; except that, in addition to the usual shunt and series windings, it has a special speed-regulating winding, the current for which is supplied from the motor-control box. It is well known that the speed of a D.C. motor is increased when the field current is weakened, and decreased when it is strengthened. This fact is utilized to regulate the speed of the motor.

D.C. and A.C. Systems

The field winding for the pilot generator is supplied with current from the mains. In the D.C. control box are three vacuum tubes (see Fig. 1). Two of these are rectifiers, taking the pilot generator current and changing it to D.C. to supply the regulating field on the motor which was just mentioned.

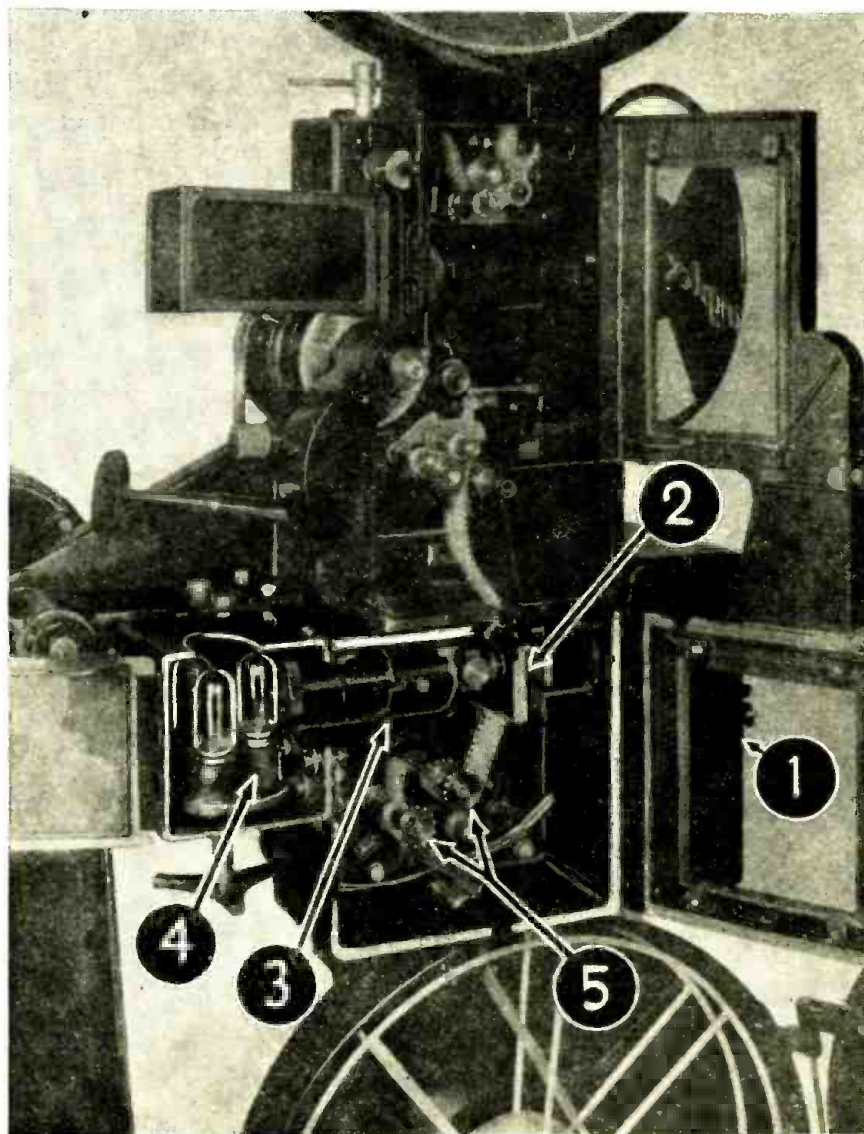

Fig. B

"Sound-on-Film" units which comprise the "pick-up head": 1, photoelectric cell; 2, aperture plate and mechanical filter; 3, lens system; 4, working and emergency exciting lamps; 5, film driving sprockets. (Photo courtesy RCA Photophone, Inc.)

The amount of current these tubes will pass depends on their grid bias; this is controlled by the third tube, which in turn is operated as an amplifier by the tuned circuit. At speeds below 1200 R.P.M. the grids of the rectifier tubes are negatively biased and therefore the rectified current through the motor regulating field is small, permitting it to speed up. At 1200 R.P.M., the tuned circuit functions and the negative grid bias of the rectifier tubes, is, in consequence, decreased; this causes the regulating field to strengthen, so that no further rise in speed can take place. If the speed tends to go above 1200 R.P.M., this effect becomes still more pronounced.

The motor used on A.C. supply is of the repulsion type. Such motors have two windings: the stator winding, which is fixed and receives power from the mains; and the rotor winding, which is on the revolving part of the motor and is not connected to the power supply. The latter winding is connected to a commutator which has two brushes. If these brushes are connected through a circuit, so that current can flow from one to the other, then the speed of the motor will depend on the amount of this current; and so, by regulating the latter, we can regulate the speed of the motor.

The A.C. motor-control box contains four vacuum tubes, (see Fig. 2). Of these, one is used to supply rectified current for the field of the pilot alternator. Two more tubes act as rectifiers, supplying current to one winding of a special choke coil, which has a second winding placed in the circuit which connects the motor brushes. When the current through the first winding is large, the choking action is not very pronounced; therefore a relatively large rotor current can pass, and the motor can speed up. As the current through the first winding is decreased, the choking action of the coil is increased, and the motor speed begins to be limited. Therefore, the motor speed can be controlled by regulating the output of the rectifier tubes. Their output depends on the bias supplied to the grids; and this in turn is controlled by the fourth vacuum tube which is operated as an amplifier by the tuned circuit. At speeds below 1200 R.P.M., the grids of the two rectifier tubes have very little negative bias and these tubes therefore pass a relatively large current through the first winding of the choke coil. Therefore a large rotor current circulates, allowing the motor to speed up. At 1200

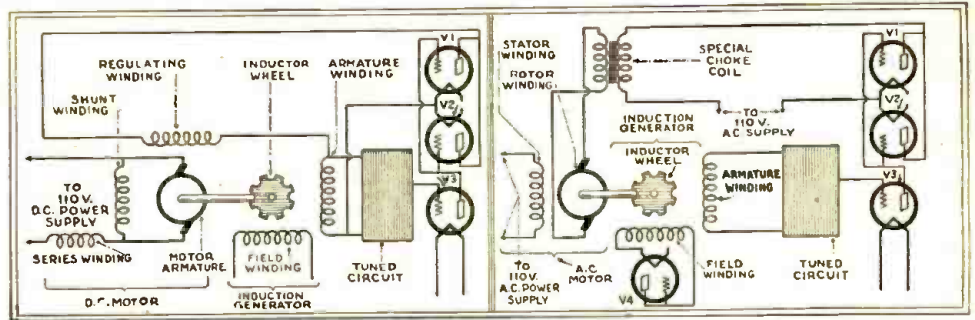

Fig. 1

Fig. 2

The respective methods employed to hold the speed of the motor operating the projection machine and (with disc method) turntable are shown above. Left, D.C. equipment; right, A.C. installation; the operation of the two speed-control systems is described in the text.

R.P.M. the tuned circuit functions, causing the negative bias of the rectifier tubes to be increased. This decreases their output, causing the choke coil to cut down the rotor current, checking any further speed increase. If the speed tends to go above the 1200 R.P.M., this effect becomes still more pronounced.

Further refinements are introduced into the motor-control box circuits, to sharpen the speed regulation and eliminate any tendency to momentary unsteadiness of speed; but these do not affect the main principles which have just been outlined.

Sound Amplification

The first step in synchronous reproduction is to generate a small electric current whose variations correspond to the sound waves forming the voice, music, or whatever is recorded.

In accordance with whichever of the methods of recording was used, this current is obtained either from an electrical reproducer playing on a disc record, or from a film reproducing apparatus, through which the film passes after leaving the projector head.

The small current from the electrical reproducer or photoelectric cell passes along to a selector switch (See Fig. 3) for film or disc; and from there to an instrument called a fader. The purpose of this instrument is two-fold. The acoustical condition of a theater, due to its dimensions, architectural features, and especially the size of the audience, varies considerably from time to time; so that the fader serves, first of all, as a convenient means for controlling the volume level of the reproduced sound in

order to achieve the most natural and pleasing results. The proper monitoring of a sound presentation to meet the existing conditions contributes much toward the success of the program. The fader provides also for reducing the output of an expiring film or disc sound-track to zero and, subsequently, building up the level of the new sound-track to the proper value.

An abrupt change from one sound-track to the other at the full volume levels gives rise to undesirable "transients" in the electrical systems. By use of the fader, the change from one projector to the other can be made in such small steps that it is not perceived by the audience; and transients are minimized, even though the transfer is made as quickly as possible. The connections for a fader are shown in Fig. 4. The sound current then passes along to a control panel (P.A.) containing one or more vacuum-tube amplifiers similar in principle to those used in the audio-frequency stages of radio sets. These amplifiers powered by a power supply system (P.U.) deliver a powerful output current to the "horns" or sound reproducers (R1 and R2) located on the stage behind the screen.

The Reproducers

There are two types of sound reproducers commonly used in sound projection. They are; first, the dynamic speaker with the auxiliary field coil; this is usually used with a baffle board and back drapes to prevent interference of the sound from the back of the cone with that generated at the front. The other type is the exponential horn, and the principle of this is that the horn forms an air column which expands at the same rate as the sound wave itself. The number of horns used, and their exact positions, depend on the size and acoustic properties of the house. The horns are placed immediately behind the screen; so that a perfect illusion, that the voice or music is coming from the speakers and artists seen on the screen, may be obtained in all parts of the house. Obviously, if the sound is not coming directly from the screen this illusion is lost.

The horns, as well as the screen, may be mounted in such a manner that they may be removed whenever the stage is to be used for purposes other than pictures. This can be done by "flying" them (like scenery which is hoisted into the "flies"); mounting them on tower platforms which are supported on roller wheels, or by mounting them on an elevator which drops into the stage floor.

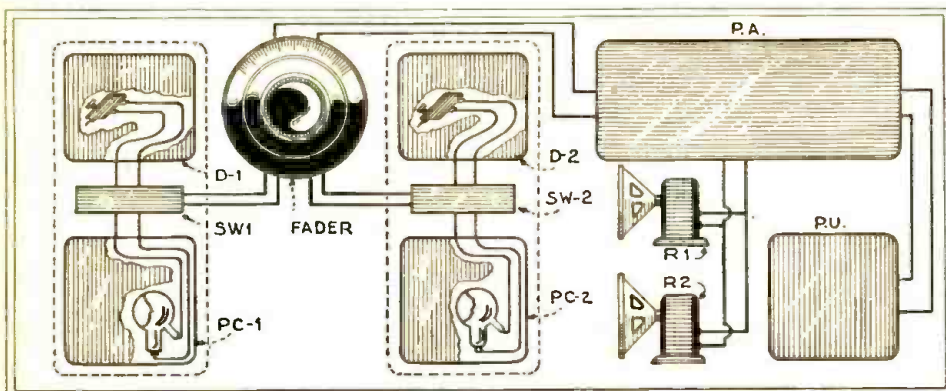

Fig. 3

The schematic arrangement of the double projectors. The sound pick-up, which may be from either disc (D1, D2) or either film (PC1, PC2), is selected by SW1 and SW2 and switched to the fader (see Fig. 4) which mixes the input as desired and passes it to the power amplifier P.A. The power supply is derived from the unit P. U.; R1 and R2 are the "horns."

The power equipment is based as much as possible on 110-volt 60-cycle current supply. Power packs and tube rectifiers are more generally used for the plate current of the tubes; while, in some cases (especially where the sound-on-film is concerned), regular "B" batteries are used to supply the proper voltage. The low voltage required for grid bias is obtained from regular dry "C" batteries. Storage batteries, motor generators, and rectified A.C. are used for the filament supply and for powering the exciter lamps. In sections where standard current supply is not available, a motor generator set is used; it operates on the local power and delivers the desired current. Some of the manufacturers have provided both D.C. as well as A.C. equipment for 110 volts, and do not have to resort to the use of motor generators except where the voltage is other than 110.

New Large Film

So far we have considered only the 35-mm. standard width film. There has lately been a tendency to change to a larger size, which has many advantages. It will allow a wider sound track, which will tend to clarify the sound considerably. The film will run at a faster speed, in proportion to its size. This will enable higher frequencies to be recorded and give a more natural reproduction of the original sound, heretofore impossible. The angular range of the field of the new film will be approximately 60 degrees against the old 30 degrees; this will enable the entire "shot" to be taken at once, rather than a section of this, and then a section of that, and a "long shot" and a "close-up." The production costs and time will be cut

approximately 25 per cent. from those of pictures taken on the old 35-millimeter film. The wide film will also offer many more possibilities in the color field; but this development is still in its infancy, and its sponsors are not yet satisfied as to the most advantageous width. The Paramount-Famous-Lasky Corporation has developed a wide film, however, which has proved highly successful in experiments. It is 65-millimeters (2.6 inches) wide, with standard-size sprocket holes, spaced five holes to the frame. The picture itself is 23 millimeters high and 46 millimeters wide. The sound

track is 6.35-mm. wide, and separated from the picture by a black band 0.65-mm. wide. The manufacturers are providing an arrangement whereby they can give the small house with a 25-foot screen the same results, by a process called "optical reduction." The screen to be used in the Paramount Theatre in New York for this new film will be 23 feet high and 46 feet long.

In the next issue of RADIO-CRAFT will be described various types of sound pick-ups, in common use in the theaters, as well as problems of operation and the methods of recording and reproducing in general.

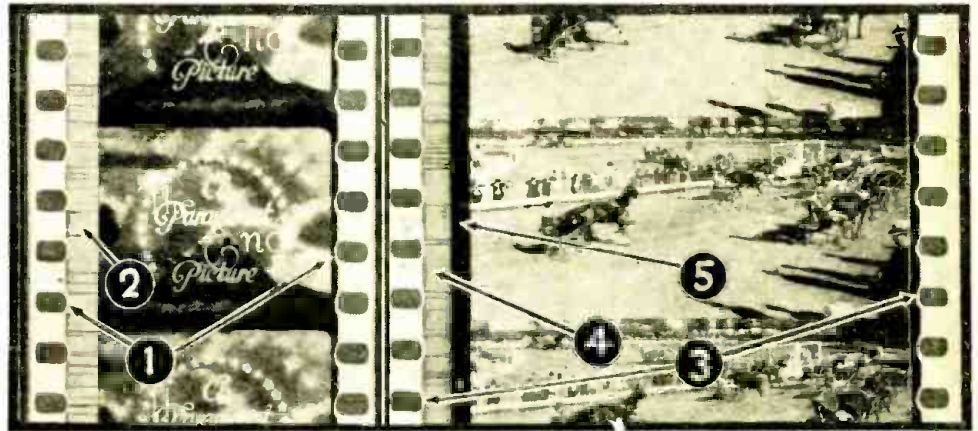

Fig. C

At the left, standard 35-mm. talking film; modulations on the sound-track 2 may be seen clearly between the sprocket holes 1 and the picture. At the right, similarly enlarged, a section of 70-mm. film now being demonstrated experimentally; with sprocket holes 3, and sound-track 4, separated from the picture by a wide black band 5. A special wide screen is needed for its projection, which presents new engineering problems.

(Courtesy of Paramount Pictures Corp. and of Adolph Zukor)

Amplifying the Television Signal

(Continued from page 452)

of V_2 becomes lower with increasing frequency, R_2 (effective) becomes

$$\frac{R_2 X_c}{R_2 + X_c}$$

where X_c is the capacitive reactance; and the output capacity of the preceding tube is effective in a like manner across R_1 .

At the high frequencies there is a still further decrease in the effective gain per stage, due to the feed-back of energy across the grid-plate capacity, and the calculation becomes of increasing complexity. Experimental determination of the high-frequency response becomes our sole means of accurate evaluation; and we can merely play safe by holding R_1 and R_2 low enough to nullify the effects of parasitic capacities.

Filtering by means of resistances and condensers does much toward keeping the elements at their assigned values, by terminating each resistance effectively at ground and keeping the signal voltages out of the battery circuits. The arrangements are shown in a self-explanatory manner in the schematic of the completed amplifier (Fig. 3).

Before attacking the design of the complete amplifier, an explanation of one peculiarity is in order. As the signal passes through each stage, it becomes shifted in phase by 90° and, if an uneven number of phase shifts take place, the resulting image

will be *negative*. Assuming the first shift to take place in the detector circuit, we require an audio amplifier of either one or three stages. In power-detector circuits, the detection takes place in the plate circuit of the tube and no reversal occurs; therefore, we employ either two or four stages of amplification.

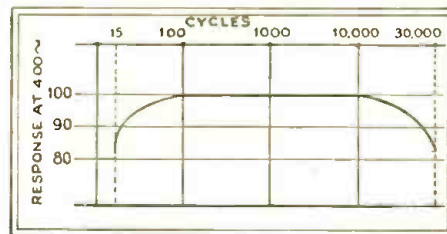

Fig. 4

The standard, 100%, is the reproduction of a 400-cycle note. The characteristic of the amplifier is practically straight between 100 and 10,000 cycles; between 15 and 30,000, it does not fall off enough to destroy the televised image.

TABLE II

	3rd Stage	2nd Stage	1st Stage
E_p	45	24	24
μ	60	30	1.5
μc	3.5	300	300
E_g	2	20	20
E_c	30	1.5	.075
E_e	50	3	3
E_b	250	180	180

Assuming the first case and taking the required output R.M.S. voltage as 60, we decide upon a '45 type tube for the output stage; since this is the most economical tube capable of supplying this voltage under the power output conditions encountered—that is, 60 volts across 10,000 ohms (the approximate impedance of the neon tube).

The design of each stage (as indicated in Fig. 2) is shown in the data of Table 11. The values of R_2 and C are chosen to give a reproduction factor of 95 at 10 cycles, with a fairly low-resistance leak, to avoid the shunting effects of the grid-filament capacity.

The bias is chosen so that it cannot swing positive at any signal voltage which is probable; i.e., each individual stage is so proportioned that there is but slight danger of overload.

A frequency-characteristic taken with one of these amplifiers is shown in Fig. 4. It can be seen that the curve is superior to that obtained with even the best transformer-coupled amplifiers, and that it holds closely to the limits set in the opening paragraphs.

In the schematic drawing (Fig. 3) the D.C. voltages given are not the effective terminal voltages, but include excess voltage to compensate for the IR drop in the plate circuits.

The Cooperative Radio Laboratory

An analysis of the comparative efficiency of different R.F. amplifiers on short and long waves, and an introduction to the director's new "filter-back circuit"

By DAVID GRIMES

AS you know, all sciences progress, through various stages of development, largely because of engineering effort. The automobile industry and the motion-picture business are typical illustrations of this; and radio presents no departure from the common rule. From the outsider's viewpoint, of course radio has improved; haven't we much better tone quality and more artistic furniture? No one questions these facts. Yet, underneath the surface, there have been other developments of even greater interest from the technical standpoint; improvements which are not conveyed to the buying public, except by rather formidable and erudite advertisements; which are far above the average reader's comprehension anyway.

One of these sub-surface studies will be the subject of our Cooperative Laboratory conference this month—the strides which have been made toward uniform radio-frequency amplification throughout the entire broadcast band of wavelengths. And, right now, please be straightened out on one notion: there is no such thing as uniform or equal R.F. amplification over the entire band—at least, not practically. Most radio receivers whose enthusiastic advertisers acclaim them afar as possessing such utopian qualities are, in the plain, unvarnished vernacular, just full of "hooy." Some of the best sets come within 50% of it; some of the worst—but why talk about them?

Good Old-Timers

The above figure will probably come to many of you as a distinct shock. Modern radio-frequency measuring instruments have surprised us, too, on several occasions. Sets we thought wonderful in their day are now disclosed, in the light of modern development, as quite mediocre. If we go back far enough, however, we find some pretty fair receivers, so far as "equal" R.F. amplification is concerned. These circuits will be found among the "fixed" R.F. transformer combinations; such as the Inverse Duplex, the Acme Reflex, the DeForest Reflex, etc. Fig. 1 gives a characteristic radio-frequency amplification curve of these untuned R.F. transformer circuits.

Then there was the old superheterodyne;

which was very good for both high- and low-wave amplification, because of the principle on which it functions. Every desired broadcast wavelength is brought in and promptly converted to a new wavelength where it is amplified prior to detection. This new, or intermediate, wavelength is the same for every station; so naturally all of the stations will be amplified with uniform efficiency. But even the superheterodyne "fell off" badly at the longer waves, as compared with "untuned" R.F. transformers. This was due, not to discrimination in the R.F. amplifier, but to tuning discrimination. This point will be discussed in more detail later on. Meanwhile, Fig. 2 will give you some idea of where the old superhet stood.

Tuned R.F. Problems

The day of really "rotten" radio results was yet to come. It came with a vengeance with the demand for greater selectivity. You see, so far we haven't discussed selectivity; we have been concerned only with equal

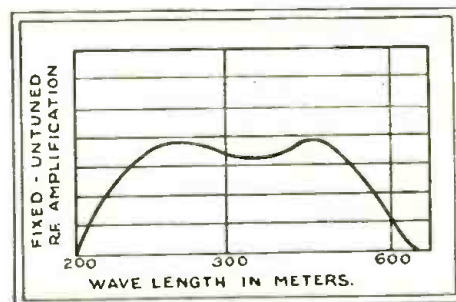

Fig. 1
The old fixed R.F. transformer circuits were fair in the middle of the broadcast band, and poor on the ends.

virtue of this very fact. In the second place, there is a tuning differential, caused by the resonant circuits in the secondary.

The R.F. voltages, placed on the grids of the tubes which are effective in producing the amplification, are furnished by the reactance voltage-drop across the tuning condenser. It is really the R.F. voltage across the tuning condenser which is placed on the grid of the amplifying tube; this condenser voltage is always equal and opposite to the R.F. voltage across the secondary which it tunes. Now it is easily seen that the secondary, being a fixed-inductance coil, has across it a higher radio-frequency drop on the high-frequency short waves than on the low-frequency long waves. Hence, there is available for the tube less resonant R.F. voltage on long waves than on short ones.

Thus we have a double-barreled effect in favor of the short waves; the primary passes more energy to the secondary, and the resonant voltages are higher in the tuned circuit itself at the short waves. And this is not all; the very coupling to the antenna favors the lower wavelength range, so long as any selectivity is desired in the first tuning stage. Of course, the coupling can be increased to the point where the initial pick-up would be practically uniform throughout the band; but such close coupling would broaden the tuning at the short waves—and the whole idea of tuned R.F. is selectivity. Furthermore, uniform initial pick-up would still leave the other discriminating factors untouched.

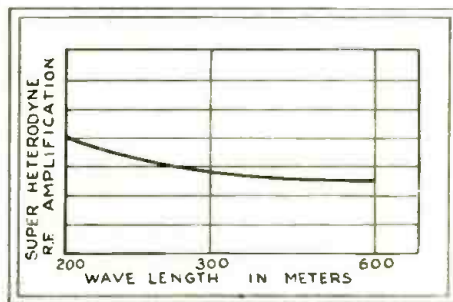

Fig. 2

The superheterodyne, with its fixed amplification, was better all the way; though not as good on long waves as on the shorter.

amplification. Let's keep these two points very much in mind; since they lead us in opposite directions when we try to put them both in a single set design.

When the now well-known, standard tuned radio frequency receiver came into vogue, we found we had far too much amplification on the short waves, and far too little on the long waves. If a multi-stage, tuned-R.F. set is designed with a reasonable number of primary turns, so that it just doesn't oscillate on the short broadcast waves around 200 meters, then the amplification almost drops out of sight on the higher waves around 550 meters. Fig. 3 gives some indication of this extreme condition; especially when compared with the gain performance of the old untuned sets in Figs. 1 and 2. It was a serious problem.

It is well, at this time, to discuss some of the whys and wherefores of this discrimination in amplification. In the first place, there is better effective coupling, between the primary and secondary windings, at the higher frequencies (of the waves around 200 meters) than on the longer waves (around 500 meters). More energy is thus passed through the amplifier on the lower waves by

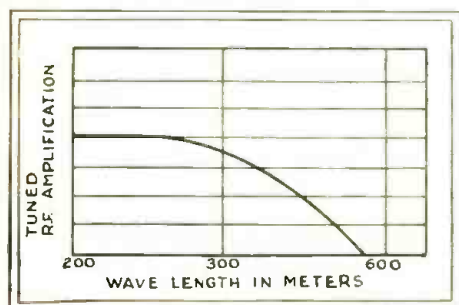

Fig. 3

The tuned R.F. amplifier, without some compensating device, is almost a total failure at the upper end of the waveband.

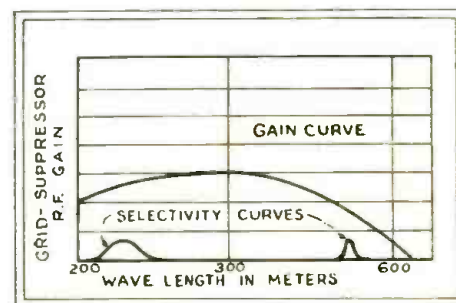

Fig. 5

With the grid suppressors, a circuit is stabilized easily and cheaply—but look at the low selectivity on short waves, and low sensitivity on the long ones.

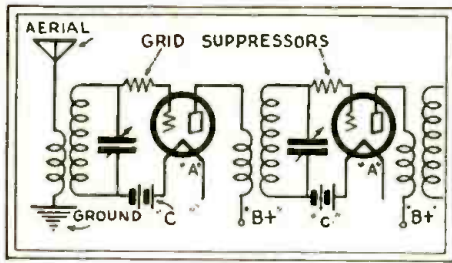

Fig. 4

The well-known, simple grid-suppressor method of keeping down oscillation; but what it does to the tuning is somebody's business!

What's to Be Done?

What has been, and is being, done to overcome this engineering defect? Well, several things—in fact, so many that it almost appears that engineers have become panic-stricken and that each is riding off in all directions! But for all this activity, the best sets are far from perfect in this regard. Let us look at some of the well-known measures, and thus familiarize ourselves with present methods; then from these, we will devise a better expedient. No doubt some of you will be able to offer the missing link which, just between you and me, is still to be forthcoming.

One of the earliest popular systems for obtaining equal R.F. amplification (and we always say "equal" with reservations) was the famous grid-suppressor stunt. Most of the Atwater Kent models, before the advent of the screen-grid tube, incorporated such an arrangement. This circuit is shown in Fig. 4. The primary coupling was increased, up to the point where fair efficiency was secured on the longer waves; and the resulting excessive amplification and associated oscillation on the short waves was suppressed by the resistor in series with the grid lead.

The grid resistor placed in this particular position automatically discriminates in favor of the longer waves. You see, when the tuning condenser is set clear in, to resonate for the range around 500 meters, the grid circuit with the grid-filament tube capacity becomes a negligible part of the tuning circuit; and the grid resistor thus fades largely from the picture.

However, there is quite a different condition existing when the tuning condenser is set clear out, for the band around 225 meters. Then the capacity of the tuning condenser is small and the tube capacity is appreciable; so that the capacity becomes a real portion of the tuning circuit, and this includes the grid-suppressing resistor. This resistance in the tuning circuit, on the short waves, cuts down the otherwise abnormal amount of gain and places it more nearly on a par with the long-wave gain. Fig. 5 gives an idea as to the amplification performance of such a receiver.

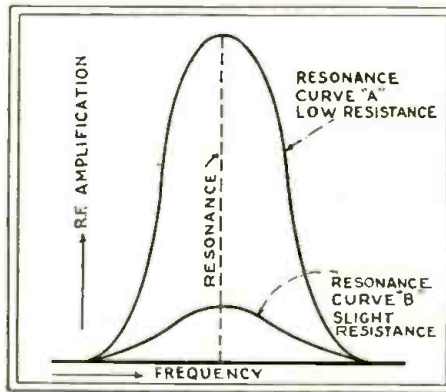

Fig. 6

The effect of a slight resistance in the tuned circuits is something tremendous, when three or more stages of amplification are employed. (See also page 438.)

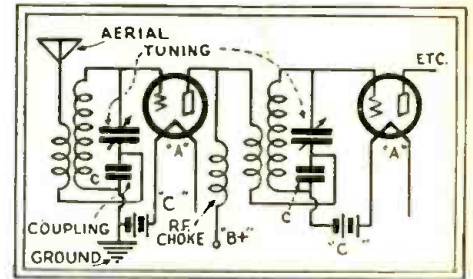

Fig. 7

The well-known Loftin-White circuit equalizes amplification, theoretically at least, throughout the entire tuning range, when capacity and inductance balance each other.

We cannot go further without giving consideration to the subject of selectivity; for, while we are interested in uniform R.F. amplification, it would be foolish to attain the realization of our desires by the sacrifice of selectivity. For instance, the grid-suppressor scheme, on the surface, presents an ideal solution to the R.F. gain dilemma. But what it doesn't do to selectivity at the short waves is "nobody's business!" This suppressing resistance reduces the short-wave R.F. amplification, by making its appearance in the tuning circuit, as already explained, and a resistance in the tuning circuit is known to broaden the tuning; it is equivalent to a high-loss tuning condenser or a high-loss coil. Fig. 6 shows what happens to the selectivity curve when only a few ohms are added to the tuning circuit. With this at hand, we can proceed to a better understanding of Fig. 5, which shows also the selectivity curves at 200 and 500 meters on a set using the grid-suppressor system. This method is not now recognized in the best regulated families, for the very reasons given.

(Continued on page 474)

One Hundred Dollars in GOLD for a SLOGAN for

A few moments of your spare time NOW may bring you \$100.00 in GOLD!



WE want a catchy slogan for this magazine. Slogans are now used universally in many different lines of business, and we believe that this magazine should be known by its own slogan.

Such slogans as "NOT A COUGH IN A CARLOAD"; "GOOD TO THE LAST DROP"; "SAY IT WITH FLOWERS," etc., are well known. A number of magazines have already adopted slogans; such, for instance, as "Popular Mechanics," with "WRITTEN SO YOU CAN UNDERSTAND IT."

We are offering \$100.00 for a novel, as well as descriptive, catchy phrase which we shall use after the end of the contest as a permanent slogan of this magazine.

REMEMBER, THERE IS NOTHING TO BUY OR TO SELL! You have an equal chance to win this prize, regardless of whether or not you are a subscriber. The contest is open to all. Get your friends in on this and, if they give you suggestions, you may split the prize with them, if you so desire.

To win the \$100.00 prize, you must submit only a single slogan, ONE ONLY. It must be an original idea. It makes no difference who you are or where you live, whether in this country or not; anyone may compete in this contest and you may be the winner.

Look this magazine over carefully and try to find out what it stands for, what its ideals are, and what it tries to accomplish. Then try to put all of your findings into a slogan which must not, under any circumstances, have more than seven words.

After you have the idea, try to improve upon it by shortening the slogan and making it sound more euphonious; but always remember that it is the idea which counts. The cleverer the slogan, and the better it expresses the ideas for which this magazine stands, the more likely are you to win the prize.

No great amount of time need be spent in the preparation of

slogans. Start thinking right now and jot down your thoughts. Also, tell your friends about it, and get them to submit slogans of their own; or compose one in partnership with them.

Here are a couple of sample slogans; which are given as mere suggestions, AND NOT TO BE USED AS ENTRIES:

"WAVES OF RADIO INFORMATION"
"IT HOOKS UP THE RADIO MAN"

RULES FOR THE CONTEST

- (1) The slogan contest is open to everyone except members of the organization of RADIO-CRAFT and their families.
- (2) Each contestant may send in only one slogan; no more.
- (3) Slogans must be written legibly or typed on the special coupon published on page 470 of this magazine. (If you do not wish to cut the magazine, copy the coupon on a sheet of paper exactly the same size as the coupon.) Use only ink or typewriter; penciled matter will not be considered.
- (4) Each slogan must be accompanied by a letter stating in 200 words, or less, your reasons for selecting this slogan.
- (5) In case of duplication of a slogan, the judges will award the prize to the writer of the best letter; the one which, in their opinion, gives the most logical reasons for the slogan.

This contest closes on May 1, 1930, at which time all entries must be in this office; and the name of the winner will be announced in the July, 1930, issue of RADIO-CRAFT, on publication of which the prize will be paid.

Because of the large number of entries which may be expected, the publishers cannot enter into correspondence regarding this contest.

Address all communications to:

Editor, Slogan Contest

Care of RADIO-CRAFT

96-98 Park Place

New York, N. Y.

RADIO CRAFT KINKS

Constructors and experimenters are invited to send in all original and ingenious ideas which they have hit upon in their work; "Kinks" are paid for at regular space rates. Make your descriptions as clear as possible; preferably by sketches, to guide our staff artists.

TAKING THE KICK OUT OF CONDENSERS

By S. H. Boyce

AFTER receiving several bad burns from pack condensers which had retained their charge for a considerable time, the writer conceived the idea of using a "Jazz Stick" for discharging them. This device,

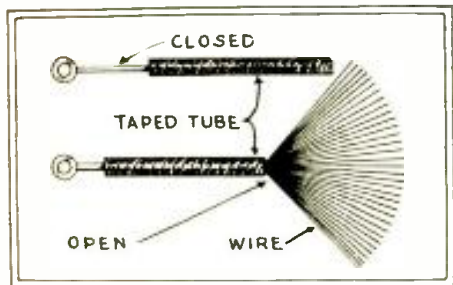

Fig. 1

This "jazz stick" may save the user from incising a wire wire, fancy steps after a jolt from a condenser.

obtainable from any musical supply house, consists of a "fan" of fine wires (arranged to collapse into the handle, for portability) and, when brushed across the terminals of a charged condenser bank, will discharge every one of the condenser units. This has been found quicker and more convenient than the usual method of using a screw-driver to short the terminals. The implement is about a foot long when open, as illustrated in Fig. 1.

Caution: Tape the handle before using the "jazz stick."

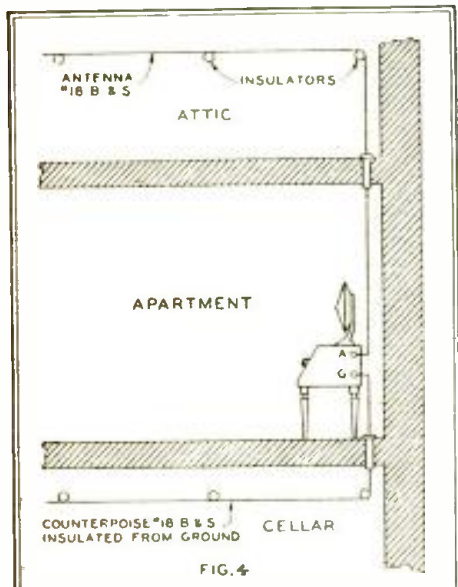

FIG. 4

The counterpoise, used in this manner, might be styled an "indoor ground" aerial and counterpoise form the "Hertzian antenna." Good results are often thus obtained.

SIMPLIFYING THE TUNING

By L. F. Carter

THIS idea is submitted to the careful set builder who wishes to reduce the number of panel controls to a minimum.

Compensation for variation in circuit capacities, at various points in the tuning range, is usually made by means of a condenser of the "set and leave alone" variety. However, this type of compensation is of value only when the remainder of the set has been very carefully designed and constructed. It is more convenient for the average set builder to arrange a small variable condenser as shown in Fig. 2, in order to obtain good circuit balance.

The trimmer generally requires only partial rotation, in relation to the full-scale rotation of the main tuning condenser with which it is made integral by means of a pulley of predetermined diameter.

The trick is to determine this ratio of movement.



Fig. 2

The simple arrangement thus illustrated makes it possible for the set constructor to tune his tuning condensers much more effectively. The pulleys are readily made by a skillful worker, though some experiment may be necessary to determine the exact ratio.

First, tune in a station near the lowest point on the tuning dial, and note the position taken by the trimmer when maximum volume is obtained. Next, tune in a station at the other extreme of the tuning dial, and again note the position of C3 at maximum volume.

Considering that, in the instance above, the two stations are 96 dial-divisions apart on the main tuning dial, and the trimmer has been turned through 24 dial-divisions, there must be a rotational ratio of four to one between the main and trimmer shafts. Therefore, proportional variation of the main and trimmer units will result when, say, a 1/2-in. pulley is put on the main shaft and a 2-in. pulley on the trimmer shaft, and the two are belted together.

To bring the minimum capacity of C1 to a balance with the minimum of C2 and C3, a small variable condenser C4 is connected in shunt with C1.

The pulleys may be made of any convenient material; the writer used some scrap bakelite.

USE OF COUNTERPOISE IN PLACE OF GROUND

By Paul L. Welker

IT sometimes happens that the set owner finds it impossible to obtain a good ground connection of low resistance and free from noise pick-up. If an efficient installation is to be made, it will be best to

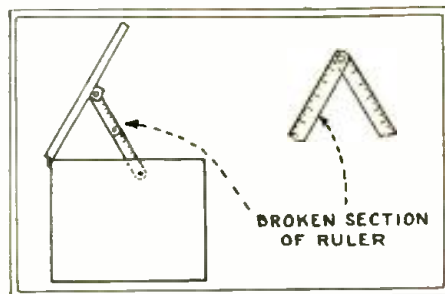

Fig. 3

Mr. Younal's ingenious use of a broken ruler is explained on page 478.

use the device, familiar to transmitting amateurs and experimenters, known as a counterpoise; this is a second (and preferably larger) aerial placed beneath the regular one, and connected to the ground binding post of the set. In places where the soil is sandy and dry, or is composed largely of rock, a counterpoise will give much better results than any ground.

Excellent results can be obtained from a single-wire horizontal counterpoise, stretched beneath the single-wire horizontal aerial. An installation made in a large rooming

(Continued on page 478)

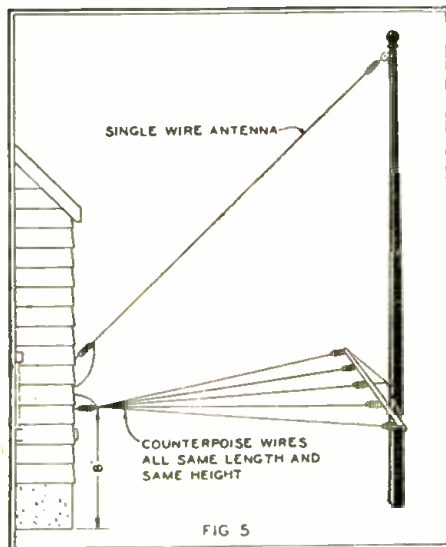

FIG 5

Another form of the counterpoise, this time with an outdoor aerial. For those who have an ample yard or acreage, this will be found even more efficient than Fig. 4.

The Radio Craftsman's Own Page

This page is reserved for the readers of RADIO-CRAFT; we shall be glad to hear what they are doing in the construction line—especially when it contains the element of novelty

BATTERY SETS STILL NEEDED

Editor, RADIO-CRAFT:

I like your magazine; your explanations are short. I read so much about short-wave sets, but they simply do not do much here. I have built quite a few; some highly praised. Would like to know how an '01A works in a tuned R.F. short-wave stage; any better than untuned?

Why not publish a few things at least on battery-operated sets? There are a whole lot of them, and always will be. The whole country didn't get A.C. overnight. You would think, from reading most magazines, that crystal sets and battery-operated were in the same class. It's nearly a disgrace to mention a '99 tube any more. (My first set contained just one '99; could have been worse at that.)

But your Radio Service Data Sheets are good. It seems to be pretty hard to get any information on most factory models. They don't want them serviced; they want to sell new ones.

A. L. GROSS,

Merriman, Nebraska.

(Mr. Gross, since his letter was written, has doubtless read the editorial in last month's issue of RADIO-CRAFT. At present, the surplus of battery sets already in existence, including trade-ins, has quite eliminated them from present manufacture. There are, of course, millions in existence—some of which will give satisfaction to their owners for years, if properly serviced. Receivers of high quality and in perfect condition are to be purchased for a song by those who do not demand—or cannot have—A.C. operation.

Because of its high inter-element capacity, the '01A tube does not amplify short-wave signals well, except where advantage is taken of its regeneration in a detector stage, which obviously must be tuned. For R.F. amplification on short waves, the screen-grid models are the only efficient tubes. Many receivers give good results with an untuned R.F. circuit, but the latest models employ tuning to advantage; especially since an "aperiodic" aerial circuit is likely to have "dead spots" at several points.—Editor.)

THE SHORT-WAVE CLUB

Editor, RADIO-CRAFT:

I have already received many inquiries about my personal reception and about the Short-Wave Club mentioned in my letter, which was published in your January issue. The club's dues are a dollar a year; and we print bulletins giving information on short-wave stations almost as soon as the news reaches us. We have also a question department, and various other things of value to the short-wave fan. At this time we have many members in other parts of the world who contribute to the information.

As to my own reception, I use a very simple circuit, and have here now (Dec. 14) verifications from 44 foreign stations, as follows: Holland, 4; France, 3; England, 7; Germany, 7; Java, 5; Australia, 3; Fiji Islands, 1; Hawaii, 1; Costa Rica, 1; Canada, 3; British Guiana, 1; Argentina, 2; Russia, 1; Colombia, 1; Mexico, 1; and the steamship *Leviathan*. I have also letters proving reception of Indo-China (1) and Siam (1).

Some of the stations I am now hearing are:

ARI, Hongkong, China: Tuesdays, Wednesdays, Fridays, Saturdays, at 8 a.m.

RA97, Khalarovsk, Siberia, 5:30 to 7 a.m.

K1NK, Manila, 24.4 and 26.2 meters—the latter being the best—7 to 9 a.m.

PLR, Java, 27.8 meters, 7:30 to 9 a.m.

ZL3ZC, Christchurch, New Zealand, 50 meters, 11 p.m. to midnight.

FZU, Madagascar, telephone to France on 16.7 meters, Tuesdays and Wednesdays, 8 a.m.

VRY at Georgetown, British Guiana, is adding power; as well as DOA (AFK) Doerberitz, Germany, on 41.46 and 67.65 meters now.

VPD, Suva, Fiji Islands, say they have three stations. I have heard the two on 20.795 and 31.3 and, I believe, the other on 38 meters.

Saigon, Indo-China, on 18.75 is heard around 8 a.m.

The latest Germans are DFA, 15.29 meters; DHA, 26.22; DHF, 26.22; DHI, 15.02; DHV, 14.6.

The Japanese are PMB, 14.5; PLE, 15.91; PLF, 16.8; PLG, 18.8; PIR, 28.8.

You might tell the world that the station of the Tropical Radio-Telegraph Broadcast Co., at Tegucigalpa, Honduras (Central America) is coming in here about R8-R9 on 51 meters. They speak Spanish and are hard to identify. Their schedule is Monday, Wednesday and Friday, 9:15 to 12 p.m., E. S. T. To Mr. Cespedes of NRII, Heredia, Costa Rica, goes the credit for identifying this station.

Mr. Cespedes expects a rival soon in a new 500-watt station under construction at San Jose, Costa Rica; nothing definite on it yet. Costa Rica may have a hundred stations, but the little NRII will always be my choice. Having heard nearly a hundred short-wave stations, I can safely say that my greatest pleasures have come from this little station and its marvelous owner. Mr. Cespedes' friends among the short-wave fans throughout this country have been sending him good-will contributions to assist him in equipping his little 7½-watt station with higher power, as a testimonial of the entertainment he has given them.

ARTHUR J. GREEN,
700 Alpha Street,
Klondyke, Ohio.

(Mr. Green sends us a bulletin of the Short-Wave Club which is crammed with information. We can heartily advise any enthusiastic short-wave fan to join. The data supplied are co-operatively collected, and will enable the readers to keep much closer to what's on the air. While the bulletin would be of undoubted interest to any "ham," it lists only stations which send voice, whether broadcasters or not; as it is intended to be of special service to the fans who cannot read code.—Editor.)

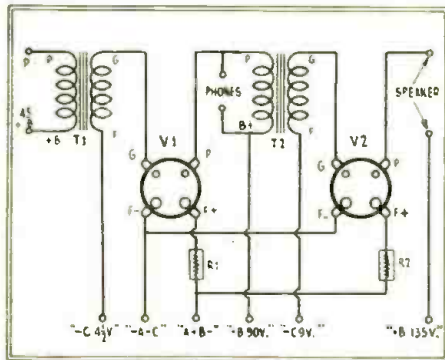

With a '12A output tube, this separate amplifier works a loud speaker nicely. Many short-wave fans will find this more convenient than the use of an adopter with their regular broadcast set.

AN AMPLIFIER FOR THE "SUN TUNER"

Editor, RADIO-CRAFT:

In the September issue of RADIO-CRAFT there appeared an article, "How to Build the Sun Short-Wave Tuner." I wish to say that I have built it, and the results I obtained exceeded my expectations. It was a surprise to me when, after listening a while to a station, I found it to be W6XX, Oakland, California. The only difference in the set I made is the fact that I shielded the tuner completely. I can regularly receive stations W8NK, Pittsburgh; W2NE, New York; W2XAD, Schenectady; and many amateur stations, both voice and code.

I added an audio amplifier to the radio just the other day and found out that I could bring in many distant stations on the loud speaker, including G5SW, England. I am enclosing a diagram of the external audio amplifier.

The parts used are: Eight binding posts; two audio transformers, T1T2, 3½:1 ratio; two 1A

amperites, R1-R2; two UN tube sockets; four Carter pin jacks; and the miscellaneous necessities.

I may add that I use a 10-ohm rheostat with a combination switch as a volume control. I find that this works so well that I omitted the one used in the tuner.

My antenna is about twenty-five feet long; it is of the ribbon type and is suspended about two feet above the building. My ground system is nothing unique, being a three-foot pipe driven into the ground.

I hope that everyone who has constructed the tuner has had the same success with it.

PAUL SKITZKI,
632 W. Green St.,
H. Hazleton, Pa.

FROM "DOWN UNDER"

Editor, RADIO-CRAFT:

I have been listening with interest to Schenectady and Pittsburgh; and the Westinghouse Co. talking to the Byrd expedition by radio. Yesterday (Aug. 8) I heard the tests. I am using a short-wave set—one screen-grid, detector and two audio (Mullard "Master Four"). Some time ago I heard a New Jersey short-wave station at about 60, dial reading—most short-wave comes through here between 0 and 30. They were insistent in asking to be notified from where they were heard; but I could not catch their call signal or name of the town—only New Jersey!

There are about 18,000 radio licenses in Wellington, population about 120,000 people. Four good stations in New Zealand broadcast. We can get the Japanese stations here on the broadcast band; also California.

MURRAY K. LITCHFIELD, D.D.S.,
53 Molesworth St.,
Wellington, New Zealand.

(Dr. Litchfield is not the only listener who would like to say: "Beg pardon; I didn't catch the name." Too much care cannot be taken in making calls plain.—Editor.)

NOW WE HAVE IT

Editor, RADIO-CRAFT:

A letter from the Secretary of Communications of the Mexican federal government states that station NDA is operating to determine the possibility of establishing radio-telephone service between Germany and Mexico. The wavelength used by NDA is 15.9 meters for daylight and 31.8 for night; it works daily with two German stations—DHA, 26.224 meters and DFA, 15.291 meters. The power is twenty kilowatts in the antenna.

I hope this will interest readers of RADIO-CRAFT who have been unable to identify this station because of the language. I find it gives a terrific signal here on 1. C. W.

FRED EASTER,
3353 Southside Avenue,
Cincinnati, Ohio.

SOUND YOUR "AH"

Editor, RADIO-CRAFT:

I am a reader, and also send RADIO-CRAFT to England and to British Guiana. I have been in the short-wave game not quite a year; but in that time I have had my thrills and blue moments. It is provoking to listen to a foreign station—perhaps France, Fiji Islands, China, Germany, etc.—and have them sign off without saying in English who they are; after you have sat and listened to the program for several hours.

I am proud of verifications from PCJ, PIII, G5SW, GBU, GBS, NDA, NRII, VK2FC, VK2ME, and Zeeson (Germany); as well as many in our own U. S. and Canada.

GEORGE J. STARRY,
299 Carlton Ave.,
Brooklyn, N. Y.

(The old trouble of the DX fans is even more (Continued on page 479)



INFORMATION BUREAU

SPECIAL NOTICE TO CORRESPONDENTS: Ask as many questions as you like, but please observe these rules:

Furnish sufficient information, and draw a careful diagram when needed, to explain your meaning; use only one side of the paper. List each question.
 Inquiries can be answered by mail only when accompanied by 25 cents (stamps) for each separate question. We cannot furnish blueprints or give comparisons of the merit of commercial products.
 The reader asking the greatest number of interesting questions, though they may not be all answered in the same issue, will find his name at the head of this department.

Highest for the current month: J. L. EDMISTON with six interesting questions.

LOW-NOTE DISTORTION—R.C.A. "100A"—DE-COUPLING

(46) Mr. Albert Chadwick, Oakland, Calif.
 (Q.) What causes a dynamic reproducer to "boom out" on the bass notes?

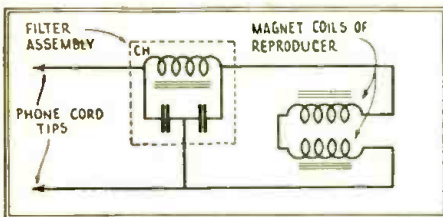

(Q46) Connections of the Radiola "100A" magnetic speaker, showing the tone filter in the input.

(A.) The first question to be settled is, whether the defect causing this form of low-note distortion is in the reproducer or in the receiver.

If the radio set gave "mellow" reproduction when a magnetic reproducer was used, it probably is the receiver that is at fault. Many radio sets are designed to operate with a particular loud speaker. If this reproducer is deficient at the lower end of the audio "spectrum," fixed condensers are so placed as to "boost" the low-note output of the set.

The dynamic reproducer works particularly well on the lower end of the audio band and, if it is connected to a radio set having an audio system that over-emphasizes the bass notes, this over-emphasis will then become very evident.

If the fault lies in the reproducer, it is probably due to resonance in the reproducer mounting, or to loose parts. If the leather mounting ring loosens, "booming" may result. Should the reproducer be defective in design, it may "boom out" when certain low notes are played; because of reso-

nance of the moving parts to notes of those particular frequencies.

If there is a "matching transformer" in the chassis of the reproducer, it is possible that this transformer is not properly matched to the output transformer or impedance in the receiver; and this causes poor reproduction of the low notes.

Incorrect "C" bias or other faults in power-pack design may be the reason.

From a consideration of these causes of distorted reception, the line of procedure becomes evident.

(Q.) What are the connections for the R.C.A. "100A" magnetic reproducer?

(A.) The connections for this reproducer are

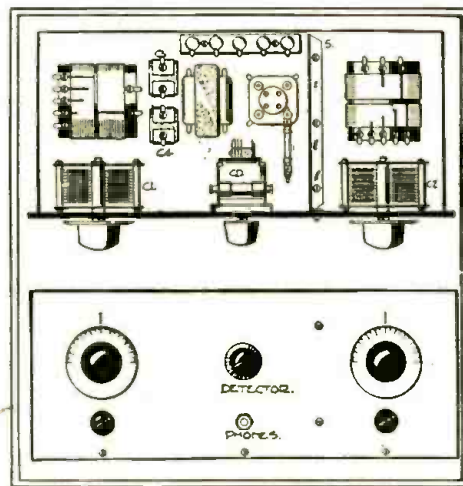

(Q47B) The layout of the Carborundum receiver as designed originally is shown above, the panel arrangement below.

shown in schematic form; it will be noticed that an audio filter system has been included in the design of this reproducer.

(Q.) Is there any convenient method of preventing the circuit oscillation that results when "B" batteries are nearly exhausted?

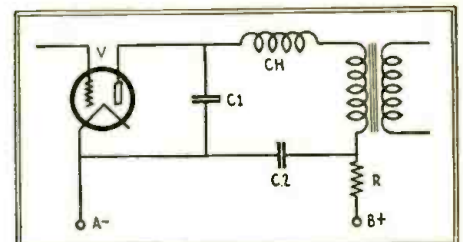

(Q46) The purpose of the resistor R is to prevent coupling through the resistance of the plate current supply of V, whether it is in a battery or a voltage divider.

(A.) The usual remedy for this condition is the use of by-pass condensers of large capacity. However, improved operation will be obtained if a "dc-coupling" or circuit-isolating resistor is inserted in the "B+" lead. It is shown in an accompanying schematic circuit as R; and has a resistance of 25,000 ohms when used in the plate circuit of a detector tube. If used in an amplifier's plate circuit, it may have a value as low as 600 ohms. It is by-passed by a fixed condenser C2, the value of which is between 0.25-mf. and 2.0-mf.; the latter value being required where the amplifier is designed for good low-note reproduction. Condenser C1 is the usual .006-mf. capacity by-passing the detector's plate choke Ch. A somewhat similar arrangement, for obtaining the desired result, in which an inductance is used instead of a resistance, was described in the September, 1929, issue of RADIO-CRAFT Magazine, on page 122.

This idea may be used irrespective of whether the "B" voltages are obtained from a battery or an eliminator. Vary the "B" potential to make up the voltage drop through R.

REFLEX CIRCUITS—CARBORUNDUM—DAYFAN "OEM" MODELS

(47) Mr. Edwin L. Plummer, Hamilton, Ohio.
 (Q.) Some time ago the Carborundum Company published a reflex circuit wherein a single tube amplified both radio and audio frequencies, with detection accomplished through the use of a Carborundum crystal detector. The writer built a set according to the plans and has received the programs of WPG, WBAP, KTHS, KWKH, WGY and CFCA, among the distant listings, and about twenty-five more local ones. However, increased volume is sometimes desirable and the question is, "How can the audio output of this reflex set be increased?" The theory of reflex operation is not clear to me.

The constants of the circuit are as follows: L1 and L2 are wound on a three-inch bakelite tube to a total length of 3 1/2-in. L1 consists of 32 turns of No. 24 D.C.C. wire tapped at every eight turns, and spaced 1/8-in. from L2 which consists of 45 turns of the same size wire. L3 and L4 are wound on a form of the same size as L1 and L2; but

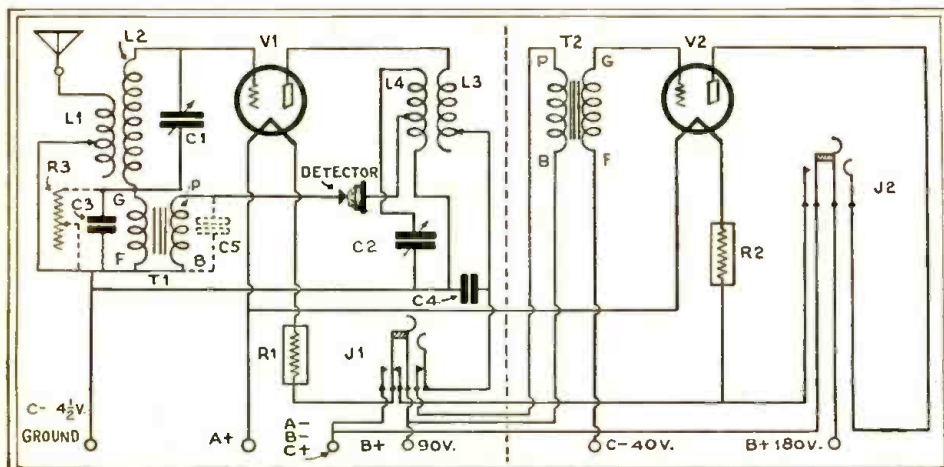

(Q47A) The schematic circuit of the Carborundum single-tube reflex receiver; with the modifications desirable, in order to add a second audio stage and provide good loud-speaker volume on strong signals. The amplifier unit is at the right of the dotted line.

RADIO NEEDS YOU

Let RCA Institutes show you the way to SUCCESS in this fast-growing industry

REACH out for a big-pay job in Radio... Tie-up to the fastest-growing industry in the world today... See for yourself what other men have done... You, too, can do the same! Hundreds of fellows just like you are now earning from \$2,000 to \$25,000 a year in RADIO. J. H. Barron, Radio Inspector of the U. S. Department of Commerce says that a most serious shortage in trained Radio men exists right now. Thousands of trained men are needed. Broadcasting stations, manufacturing plants, retail and wholesale dealers, as well as ships at sea and planes in the air, require trained Radio men.

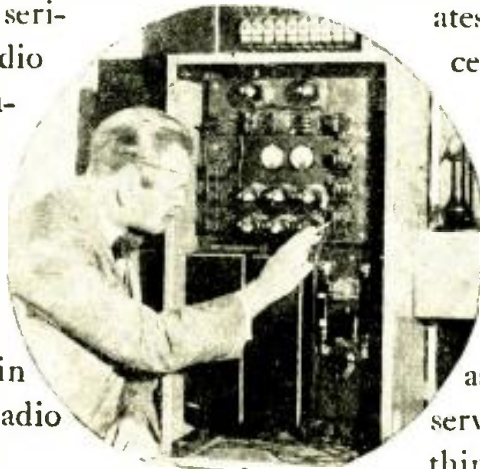

Radio Mechanics earn up to \$4,800 a year.

very source of radio achievement... the vast world-wide organization that has made Radio what it is today... that sponsors every lesson in this course.

RCA Graduates Find it Easy to Fill Good Radio Jobs

There has been a radio job for practically every graduate of RCA Institutes. Graduates are actually *Trained* for Success because they learn radio by actual experience with the RCA Institutes famous outlay of apparatus given to every student of this course. You learn to solve every radio problem such as repairing, installing, and servicing fine sets. Here is everything you need know in order to fill a well-paid position in Radio.

*Learn Radio at Home...
RCA Institutes Will Train
You for Success!*

*Send for this Free Book
"Radio... the Field of
Unlimited Opportunity"*

RCA sets the standards for the entire radio industry. The RCA Institutes Home Laboratory Training Course gives you the real, inside, practical training in Radio, quicker than you could obtain it in any other way. It's easy to learn at home in your spare time. You get your lessons and criticisms direct from RCA... the

Read these 40 fascinating pages, each one packed with pictures and text that tell you everything you want to know about the many brilliant opportunities in Radio and about RCA Institutes, the world's oldest and largest radio training organization. Tune in on Radio. Send for this free book today and speed up your earning capacity!

Clip this Coupon NOW!

RCA INSTITUTES, INC.

Formerly
Radio Institute of
America



RCA INSTITUTES, Inc.
Dept. RC-3, 326 Broadway, New York

Gentlemen: Please send me your FREE 40-page book which illustrates the brilliant opportunities in Radio and describes your laboratory-method of instruction at home!

Name

Address

L3 consists of 48 turns of No. 30 D.C.C. wire, tapped at every twelve turns, while L4 has 45 turns, center-tapped. C1 and C2 are .0005-mf. variable condensers, preferably with grounded rotors; C3 is .0001-mf.; C4, .0005-mf.; R1, a suitable filament ballast for the particular tube used as V1; R3 (required only if uncontrollable A.F. oscillation occurs), has 50,000 ohms resistance minimum, and 500,000 ohms maximum (it is variable within these limits); Detector, Carborundum crystal; S (shown only in Fig. 47B) is a metal shield placed between L3-L4-C2 and the remainder of the components, and is 6 1/2 inches high by 8 inches long.

(A.) A schematic circuit of the desired arrangement (Fig. 47A) is shown in these columns. V2 is the added tube, arranged as a second stage of A.F. amplification; the "B" and "C" potentials shown are the correct values for a '71A tube; although any other power tube may be used if the current supply is adjusted accordingly.

For convenience, the idea of the filament-control jack has been retained; but the old jack is now shown as J2 and a new one, J1, replaces it in the former position.

If the A.F. transformer T1 has a ratio of about 4 to 1, T2 may have a ratio of 2 to 1, if of good design; otherwise, the volume may not be as great as desired. It is suggested that C5 placed as shown, with a capacity about .00015-mf., might improve the operation of the circuit. R2 is the filament ballast required for the particular power tube selected. The old circuit is shown at left of dotted line, and the added A.F. amplifier at right; this unit being constructed in any convenient manner.

A study of the action of a reflex circuit appears in the December, 1929, issue of RADIO-CRAFT Magazine, in Radio Service Data Sheet No. 7.

(Q.) What is the difference between the Day-Fan model "OEM-11" 3-tube and model "OEM-7" 4-tube sets?

(A.) It was found that the three-tube set became overloaded when operated near high-power stations; hence the four-tube set was designed. The three-tube set has its first stage of R.F. reflexed for the second A.F. stage; the second R.F., reflexed for the first A.F., also feeds the detector. The four-tube set has only its second R.F. reflexed (for first A.F.), a separate (fourth) tube functioning as the second audio stage.

R.F. COIL CHANGES—TELMACO "P-1" PORTABLE RECEIVER

(48) Mr. C. W. Hooper, Chicago, Ill.

(Q.) Is it harmful practice to compensate, for capacity between turns in an R.F. coil that has been space-wound, by forcing together a few turns

at one end in order to increase or decrease the capacity? Will this practice result in a change in the over-all capacity and prove detrimental to the operation of a radio receiver? The coil under consideration is a straight-wound one and the over-all winding is tuned by a variable condenser. This method has been used to help balance receivers; but I have been told that it tends to throw the receiver off balance.

(A.) It is presumed that operation of a gang condenser is the objective; otherwise, such accurate balancing of coil characteristics would not be necessary. The first point to be considered is that each tuned circuit should have its inductance and capacity distributed in the same proportions. For best results, the self (turn-to-turn) capacity of the coil should be evenly distributed along the length of the winding; however, if it is "lumped" at one end or the other of one coil, it should be similarly lumped in the other coils. If the turns are forced out of their original positions the wire is usually loosened slightly, and then the entire coil becomes loose in a fairly short time; since temperature variations cause expansion and contraction of the tube on which the wire is wound. This is a mechanical objection to the idea.

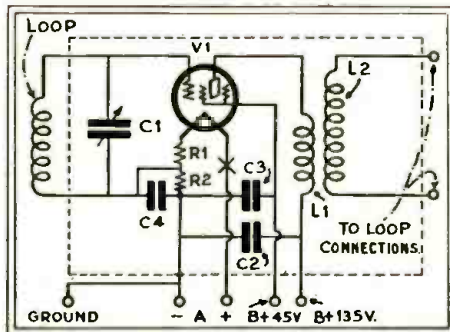

(Q49B) This unit introduces a stage of R.F. screen-grid amplification between the loop of a superheterodyne and its regular first detector.

Pushing turns backward and forward would not be so objectionable if the result were really as expected. But such attempts at circuit balancing are usually made in the wrong place, and not at the source of the trouble; moving turns to balance a coil is like bending a condenser plate to balance a condenser; for both usually result in causing an unbalanced condition at the other extreme of the tuning scale.

It is preferable to balance a coil by removing or adding turns until resonance at a particular frequency is obtained when a standard capacity

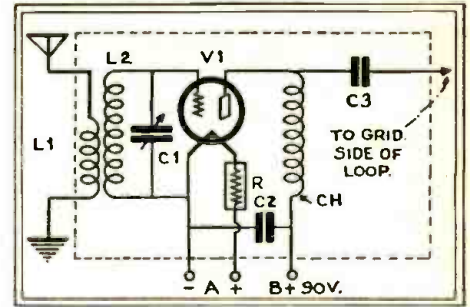

(Q49A) This shielded booster unit may be coupled ahead of a loop-operated set, to increase pick-up and selectivity.

value is used in shunt; a small condenser may then be placed in shunt with the tuning condenser and coil when assembled as a unit, and the minimum capacity of the circuit matched to the minimum of the other circuits. If the placement and design of the parts have been correct, the circuits should tune correctly throughout the tuning range. If they do not, the origin of the fault should be determined.

(Q.) What is the schematic circuit of the Telmaco "Type P-1" portable receiver? Please indicate all electrical values.

(A.) The circuit of their receiver is shown here, with the approximate position of each part as it is in the completed receiver. The constants follow: T1, T2, T3 are 3-to-1 ratio "Hegehog" A.F. transformers. The R.F. transformers, of the "fixed" or aperiodic type, are indicated as RFT1, RFT2 and RFT3. C1 is a .0005-mf. Remler, equipped with a special plate P (essential for best results); Det. is an adjustable crystal detector of the panel-mount type; R1, a 400-ohm potentiometer; R2, 6-ohm rheostat; Sw1 is a panel-mount S.P.D.T. switch (for selecting the built-in or the external loop); J1 is a closed-circuit jack (making telephone or loud-speaker operation optional); R3 is a filament ballast (in some models this resistor has a value of about 3 ohms; in some it is 6 ohms; and in a few instances the circuit has been wired without this unit, entire control being effected through R2).

The panel size of this receiver is 5 1/2 x 17 1/2 inches; the baseboard measures 5 13/16 x 17 inches. Three dry cells supply the "A" current, and the recommended "B" potential is 67 1/2 volts. It may be necessary to try several sets of '99 tubes before a good combination is obtained. The sockets should be of the "shock-absorbing" type. V1 is the first R.F. amplifier; V2, second R.F. and first A.F. (reflexed); V3, third R.F. and second A.F. (reflexed); V4, third A.F. All are type '99.

A loop for this set may take any convenient form; the length of wire required is approximately 100 feet, the turns being spaced about 3/4- to 1/2-in. This external loop is led to "G" and "L" posts, connection to this antenna being made when Sw1 is turned to "external loop." A light-socket or short outdoor antenna may be connected to binding post "A"; a ground is recommended at "G."

"RADIOLA 25"—USE OF R.F. UNIT WITH LOOP RECEIVER

(49) Mr. J. L. Edmiston, Riverside, Calif.

(Q.) A Local Service Man tells me that the "Radiola 25" six-tube dry-battery superheterodyne will give better all-round performance if equipped with '01A tubes, by using offset socket adapters to provide clearance for the larger tubes and substituting a six-volt storage battery for the filament supply. If the scheme is practical, it is probable the voltages of the power stage would require correct adjustment. What is your opinion regarding the thought?

(A.) It is quite true that storage-battery tubes may be substituted for the '99s; however, we cannot find sufficient merit in the idea to give it our approval.

In the first place, the Radiola superheterodynes are engineered to a high degree. Every turn of wire and capacity value in the layout has been determined after extensive laboratory work; and all on the basis of the characteristics of the '99 tube.

For instance, the average grid-filament and plate-filament capacities of the '99 are 3.8 mmf. each, while the '01A averages 5.4 mmf.; and again, the

(Continued on page 479)

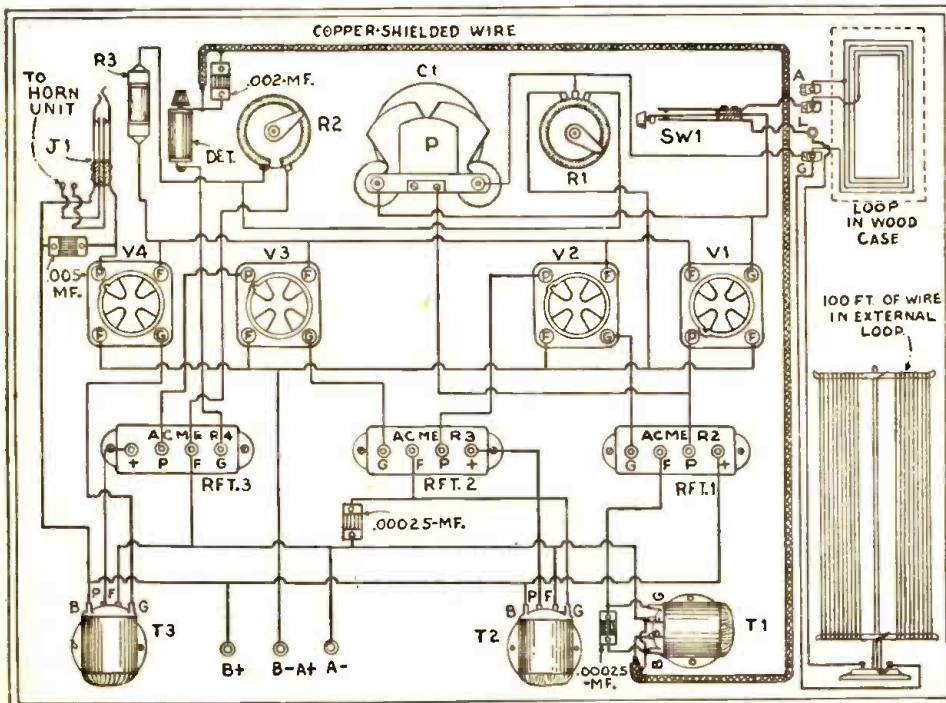

(Q48) The "Telmaco P-1" portable receiver, with optional loop and aerial and ground connections. The set, with its reflex circuit, gives three R.F. and three A.F. stages with four 'V99 tubes. The battery consumption is very economical.

Radio's Greatest Bargains!

As Long As the Supply Lasts

Send for
FREE
RADIO
SET
CATALOG
A Postal
Card
Brings It.



Price \$10.95

THESE are the greatest radio set bargains that have ever been offered. The radio sets listed here are standard sets made by the greatest and best known radio set company in America.

All of these sets are battery sets; but this is only one reason why they are sold at such ridiculously low prices.

The other reason is that these sets are mostly demonstration and display models from New York's largest radio and department stores.

We have been able to make connections with a number of houses in New York City, and we secured these fine sets at remarkable prices. Due to these circumstances, we are enabled to sell them to you at only a fraction of their original cost.

Important!—Set Builders, Constructors and Experimenters

Even if you do not need any one of these fine sets, here is a tremendous opportunity to get parts at prices next to nothing. Everyone of these sets contains in addition to the valuable cabinet, a goodly quantity of radio parts, such as, condensers, transformers, sockets, tuning dials, coils, etc.

These sets contain from \$25.00 to \$50.00 worth of radio parts, if you had to buy them separately. In many cases, it will pay you to rip a set apart in order to get these valuable parts at unheard of prices. So, even if you do not need a set, the tremendous value in the separate parts will recompense you for the small outlay.

TURN THESE SETS INTO BIG MONEY!

There are still many families and many houses not equipped with radio today. At the prices at which we are selling them, it will pay you to install these sets and sell them at an excellent profit.

A number of our customers have made as much as \$20.00 and \$30.00 on each one of these sets by installing them, incidentally making a profit on tubes, loud speakers, etc.

Remember, we do not sell you these sets as brand new. They all have been used somewhat, but they are all in excellent condition, and, by doing over the cabinets with some furniture polish, or otherwise renovating them, they will make a first class appearance and, in most instances, you will not be able to tell the set apart from a new one. This is your great opportunity to make a few extra dollars, and we trust that you will not let this opportunity go by.

We promise prompt shipments. We have a large supply of these sets on hand, and, in most cases, can ship within 24 to 48 hours.

ALL SETS ARE TESTED BY OUR EXPERTS AND WE GUARANTEE THEM TO WORK SATISFACTORILY.

Radiola 25 Superheterodyne

The Radiola 25, made by the General Electric Company, and sold by the Radio Corporation of America, is a genuine "Superheterodyne." This is a special circuit, the patents of which are jealously held by the R. C. A. and infringement is vigorously prosecuted, due to the value of the circuit. The particular adaptation used in this receiver is known as the "second harmonic" circuit. All the "intermediate frequency transformers" are contained in a "nickel-plated catenoid." This catenoid alone cannot be bought for less than twelve dollars, and to have one of these installed in the 25 costs, usually, NOT LESS THAN EIGHTEEN DOLLARS. In addition, there are all the other parts, such as the tuning condensers, coils, loop aerial, etc.

The "25" is a loop-operated set. No outside aerial is needed, but an antenna may be used if desired, by running its lead-in close to the loop, or making a single loop in the lead-in and placing this loop in inductive relation to the loop on the "25."

A 2-mf. by-pass condenser is contained in the cabinet. A marked, color-coded cable is provided for battery connection. Sturdy 41-plate (brass) variable condensers ("straight line frequency" type) with pigtail rotor connections are used for loop and "oscillator" tuning. In Brooklyn, with this set we tuned in WLW, of Cincinnati, at noon, with WOR broadcasting on one side and WJZ on the other! This is physically impossible unless the receiver has "10-ke. selectivity."

Tuning of this receiver is accomplished through large "thumb-operated" tuning drums, so designed that stations may be "logged" directly on the drums. Two 1 1/2 jacks are provided for testing filament potential. The small center knob controls a multiple-contact switch which changes the circuit to include one or two stages of A.F. amplification. Additional volume control is afforded by panel-mounted rheostats of the cartridge type. Two jacks for headphone use. Some constructors have stripped these receivers and reassembled the parts in an entirely different layout, resulting in a very compact, super-sensitive arrangement in portable form, the entire equipment being ideal for such design. The loop is 12 inches wide, 28 inches high and 5 inches across the top; and center-tapped.

A two-tone mahogany-veneer cabinet of original pattern houses the chassis and all batteries. Its overall dimensions are 28x19x12-inches high. The weight is 42 pounds. Six type 199 tubes are required.

EXACTLY as illustrated and described with cabinet and fine loop aerial. (No tubes, batteries or loud speaker.)

Shipped by freight or express collect List price of set \$265.00.

Radiola Portable [Second Harmonic] Superheterodyne [AR-812]

One of the most famous radio sets in America. Each cabinet is said to have cost twelve dollars to make. It is solid wood and finished in mahogany. This set may be placed on a table, the battery switch turned to "on," and music will be heard—without an outdoor antenna; it works with a loop aerial which is built inside the cabinet. The set is super-sensitive and, in certain localities, it is possible, on the east coast, to hear west coast stations. The cabinet holds all the batteries for the six "dry-cell" tubes required.

In locations near strong broadcast stations interference may be experienced. That is, a station may be heard several times. To overcome this, some experimenters have preferred to tune in the short-wave stations and then use their AR-812 as the INTERMEDIATE FREQUENCY AMPLIFIER of a superheterodyne hookup. This is accomplished by tuning their superheterodyne to a broadcast wave on which there is no interference. Then, short-wave signals are "heterodyned" from the short waves to the wavelength to which the super is tuned. In that way the tremendous amplification obtainable from this receiver is used to the fullest extent.

A few may wish to arrange the parts differently on another panel. In this receiver there are two large variable condensers of 31 plates each. The oscillator coils are honeycomb coils mounted on a hard rubber sheet. The main part of the set, the intermediate frequency transformers, are buried in beeswax in a shield can called the "catenoid." On the top of this can are mounted the tube sockets. A terminal strip is the terminus of



Price \$10.95

one end of a 6-wire cable for connecting the batteries. There are two porcelain base rheostats on the inside of the panel, controlled from the front; one has about 6 ohms and the other has about 20 ohms. A push-pull switch (center) turns the set on and off; another, (lower left) cuts in either one or two stages of A.F. amplification.

Although the cabinet is 35 inches long, 11 1/2 deep and 11 1/2 high, the panel of the receiver is only 19 inches long and 9 inches high. The difference lies in the two end compartments for "A" and "B" batteries. Six, type 1V199 tubes are required for this receiver. Dry-cell power tubes, the type '20, may be used in this set if a Naald or similar adapter is used. The weight of this set, without batteries is 36 pounds. Exactly as illus-

trated and described. Price includes cabinet but no batteries, tubes or loud speaker. Shipped by freight or express, collect. List price is \$220.00.

HOW TO ORDER

Remit amount by money order, cash or certified check (personal checks occasion delay). Order direct from this page at prices quoted. No C.O.D. orders on this sale accepted.

RADIO SPECIALTY CO.

BUY FROM RADIO'S OLDEST MAIL ORDER HOUSE

98C Park Place
New York City

Servicing the Freshman "QD-16S"

(Continued from page 430)

and "B" on the orange leads of the first autoformer. The meters should show continuity.

The failure of the '27 detector tube to light is due to a broken connection, or else

by putting the tester tips on the two slate-colored leads. To test the biasing resistor, put the "A" tip on the brown lead of the power transformer, and "B" on the orange lead of the second autoformer; meter should

RADIO SET ANALYSIS																					
OWNER _____		DATE _____																			
ADDRESS _____																					
NAME OF SET _____																					
TUBE NO. IN ORDER	TYPE OF TUBE	POSITION OF TUBE (1ST RF DET ETC)	TUBE OUT					TUBE IN TESTER													
			A VOLTS	B VOLTS	A VOLTS	B VOLTS	C VOLTS (ANTENNA I.M.D.)	CATHODE-HEATER VOLTS	NORMAL PLATE MA	PLATE MA GRID TEST	PLATE CHANGE MA	SCREEN GRID MA									
1	222	1 R F	3.10	130	3.00	120	3.0														
2	227	Det.	2.25	100	2.15	40	0.0		2.75	2.75	0.0										
3	226	1 A F	1.40	110	1.35	100	6.0		4.00	8.00	4.0										
4	171A	2 A F	4.80	185	4.70	170	38.0		16.00	18.00	2.0										
5	280	Rect.	4.80	630	4.70				22.00												
6																					
7		*ACROSS Secondary																			
8																					
9																					
10																					

LINE VOLTAGE 119 SET ON 120 VOLT TAP. VOLUME CONTROL POSITION _____

SUGGESTIONS OR CHANGES MADE _____

BY _____

the 2.25-volt winding is burnt out. Put the tester tips on the orange leads from the power transformer; the meter should show continuity.

The 5-volt winding for the '71A is tested

show continuity. R7, the biasing resistor of the power tube, has a value of 2,000 ohms; R8, biasing the first audio tube, 1,800 ohms.

A lack of plate voltage on the '22 is due to a defective resistor R3; absence of screen-

LIFE-TIME DX AERIAL

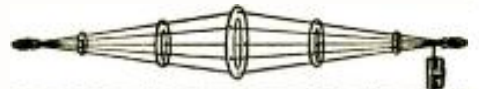

Guaranteed Double Volume and Sharper Tuning

DESCRIPTION OF LIFETIME DX AERIAL
No. 30—LENGTH 30 FEET: Assembled ready to string up. Brings in volume of 150-ft. wire but retains the selectivity of a 30-ft. aerial. Rings are heavy gauge solid zinc. Duplicates in design and non-corrosive materials the aerials used by most of largest Broadcasting Stations. Design permits using this powerful aerial in 30-ft. space (preferably outside). Sharpens tuning of any receiving set because of short length but has enormous pick-up because 150 ft. of No. 14 enamelled wire is used. Made for owners of fine radio sets who want great volume on distance without destroying sharp tuning. (Also used by many owners of short-wave outfits.) "Makes a good radio set better."

PRICE \$10.00

No. 60—LENGTH 60 FEET: Assembled ready to string up. "BIG BOY" Size (same description as above except that 300 ft. of wire is used, making this the most efficient and powerful aerial possible to manufacture).

PRICE \$12.50

No. 20—LENGTH 20 FEET: Contains 100 ft. of wire.

PRICE \$7.50

No. 15—LENGTH 15 FEET: Contains 75 ft. of wire.

PRICE \$5.00

Especially designed for Screen Grid sets or receiving sets located close to powerful broadcasting stations.

Manufactured by
THOROLA RADIO PRODUCTS
 1014 So. Michigan Blvd. Chicago, Illinois

If you are a service man, professional or radioholic, you should receive RADIO-CRAFT each month. Turn to page 474 of this issue and read the special offer to those who are actively engaged in radio.

EVERY SERVICE MAN SHOULD OWN THIS BOOK!

S. GERNSBACK'S RADIO ENCYCLOPEDIA

The First Real Radio Encyclopedia Ever Published

Regular Price \$2.00

Our Special Price \$1.49



(1930 Definitions)
FULLY ILLUSTRATED
 Size 9 x 12 in.
 Over One Inch Thick
 168 Pages
 Written in Plain English

EDITED by SIDNEY GERNSBACK, Author of "Wireless Course in Twenty Lessons" — "One Thousand and One Formulas" — "Practical Electricity Course" — "The Radio Educator," etc.

S. GERNSBACK'S RADIO ENCYCLOPEDIA is the only standard work ever published in America attempting to classify alphabetically the countless words used in the highly specialized science of RADIO. The ENCYCLOPEDIA is written in plain English so that everybody can understand the definitions and descriptions.

No expense has been spared, covering over two years in compilation, to make it worthy a place in your library.

It is published in one volume—168 pages—size 9 x 12 inches, over an inch thick and nicely accommodates the beautiful illustrations and the large, easy-to-read type.

The work contains 1,930 definitions, 549 photographs, drawings and diagrams.

REMEMBER THIS IS A REAL ENCYCLOPEDIA — NOT A DICTIONARY — and very few of the things described and illustrated in this volume can be found in any diction-

ary, or any other encyclopedia.

The book contains as a supplement a classified cross index designed to bring together radio references under one heading having relations in common.

All circuits new and old are described by word and picture and every part and apparatus used in Radio is explained and made understandable by means of photographs and drawings.

The volume is printed upon fine paper—bound in full black Keratol, marbled paper fly leaves and end sheets, with the title stamped in gold.

SEND NO MONEY

Just Pay Postman

(Canada or Foreign send Check or Money Order for \$1.75)

ISKOR PRESS, Inc., R-330
 286 Fifth Avenue,
 New York, N. Y.

Send me one copy of Sidney Gernsback's First Radio Encyclopedia in one volume as advertised. I will pay postman \$1.49 plus postage on delivery.

Name

Address

Town and State

grid voltage signifies that either R3 or R4 is burnt out. Lack of detector voltage shows that either R1 or R3 is burnt out. No plate voltage on the '26 shows that R2 is burnt out. No plate voltage on the '71A indicates that the field winding of the dynamic re-producer is burnt out. (All these statements first assume that the filter chokes and condensers are satisfactory).

The quickest way to find out if the pack is shorted is to put the "A" and "B" tips

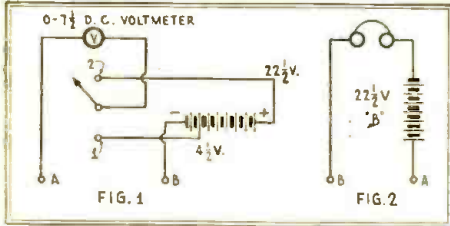

Two handy testers, whose principle is understood by all Service Men, make continuity and resistance tests quick and easy.

of the tester (Fig. 1) across the "B" terminals (with the set off); if a full reading is obtained, the pack is shorted. If there is no "B" voltage at all with the set on, the rectifier tube may be defective, or a condenser may be shorted. A punctured by-pass condenser will prevent a voltage from existing across a certain section of the voltage divider. A shorted input filter condenser (C14, C11) will cause overheating of the rectifier tube and power transformer. The plates of a filament rectifier, such as the '80, will glow also if the mid-section, or output filter is shorted.

Service Men's Notebooks

(Continued from page 426)

to drop out of its own accord. The sketch tells most of the story.

There seems to be a "knack" in winding such delicate wire without breaking it; but this is easily acquired, and after that the job is surprisingly simple.

I undertook the first job of this kind to avoid the delay due to sending the unit to the factory for repair; but have found it to be a very desirable side line to other service work.

Operating Notes

(Continued from page 429)

New York City called Brooklyn Heights. On my arrival, I found the set "percolating" in a very satisfactory manner; and a thorough examination soon convinced me that the trouble could not be in the receiver itself. There could be very little chance for the R.F. coils to absorb moisture; because the set was on the side of the room opposite the windows, and the apartment was heated by a hot-water system.

I climbed four flights of stairs to the roof, and proceeded to tear down the old aerial, without even troubling to examine it, and to erect a new. The one I put up was 120 feet from pole to pole, eight feet above the roof; the lead-in was sixty feet of No. 14 heavily-insulated G. E. wire,

"ELECTRICAL OPPORTUNITIES"

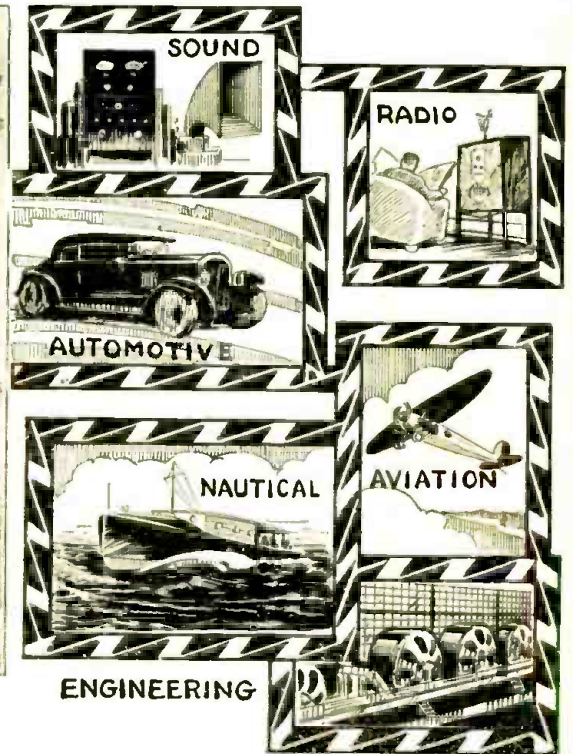
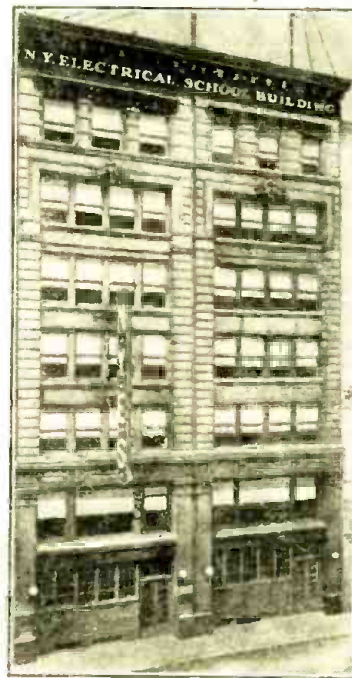

A full knowledge of electricity, as taught in the New York Electrical School, makes you independent, gives you your choice of either a BIG PAY job with one of the world-famous electrical companies, or a business of your own. ELECTRICITY is also a stepping-stone to Aviation, Automobile Engineering and other highly paid professions.

Here at the New York Electrical School you learn, not by correspondence, but by ACTUAL PRACTICE on full-size standard equipment. NO BOOKS used. Individual instruction—you can start any day. This School owns and occupies two seven-story buildings in New York—the city of most opportunities. It is widely known as the country's oldest and foremost institution for trade training. That's why big companies eagerly demand our graduates.

THE NEW YORK ELECTRICAL SCHOOL
21 West 17th Street, New York



FREE

This big 64-page booklet gives full information about the New York Electrical School courses and pictures of the equipment available for your personal use. Send for it TODAY. It's free.

MAIL TODAY

The New York Electrical School
21 West 17th Street, New York

Please send me FREE your 64-page booklet. It is understood that this request puts me under no obligation.

Name

Address

For the RADIO SERVICE Man

Every radio worker should join the ELECTRAD FORUM. Keeps you in touch with latest developments — helps solve your daily problems. Dues, \$5 per year, include unique monthly magazine of inestimable value. Write DEPT. RC3 for details and application blank.

John Fisher
DIRECTOR

ELECTRAD FORUM
1440 Broadway, New York

SERVICE MEN

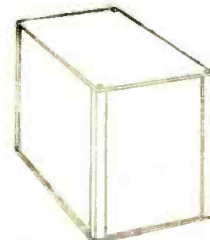

BRACH TEST-O-LITE should be in every service kit, \$1.50.

Aluminum Box Shields — beautiful silver dip finish, 5"x9"x6" — \$1.89. Any size made to order in 24 hours.

All types of adapters. Tungar tubes. Test Clips and Soft Rubber Caps 35c. pr. Bud Antenna \$1.95. Brach Relays 95c. Elkon 1500 mfd. "A" condenser \$2.45.

Genuine Baldwin Type "C" phones, a necessity for short-wave reception, \$3.65 a pair.

BLAN THE RADIO MAN, Inc.
89F CORTLANDT ST., NEW YORK

**44TH ST.
HOTEL**
Just East of B'way

*One of New York's
New Hotels at Right Prices*

A high-class hotel in the very center of Times Square and within walking distance of all Shops, Theatres, etc.

300 Rooms—300 Baths
\$2.50 & \$3.00 per Day

A Restaurant of Unusual Excellence
Special Weekly Rates

10 Tools in One

A SMALL but handy article which serves for every possible need of the all-round mechanic. Invaluable in any emergency.

An excellent combination of utilities for the household—every necessity featured: HAMMER — KNIFE-SHARPENER — NAIL-PULLER — BOTTLE-OPENER — SCREW-DRIVER — CORK-SCREW — CAN-OPENER — WEIGH-SCALE — RULER — TABLE OF WEIGHTS AND MEASURES

Just glance at the illustration and you will see how really useful this article is. The "Ten in One Tool" is 10 inches high and finely nickel-plated.

The new tool is not only handy in the household, but every TOURIST, AUTO-IST, CAMPER, PICKNICKER, BOY-SCOUT, FISHERMAN, CANOEIST, etc., should carry in his bag one of these indispensable combination tools. No SHOP, OFFICE, STORE, GARAGE, FARM, BOAT, should be without one. PRICE \$1.00, POSTAGE PAID.

Be the first one to own the "Ten Tools in One" in your own town.

Send your order today, pin a dollar bill to coupon below and the shipment will go forward to you the same day as received.

GRENPARK COMPANY
245 Greenwich Street
New York, N. Y.

Grenpark Company, RC-330
245 Greenwich Street,
New York, N. Y.

Enclosed find \$1.00 for which please send me prepaid your "Ten Tools in One."

Name

Address

Town..... State.....

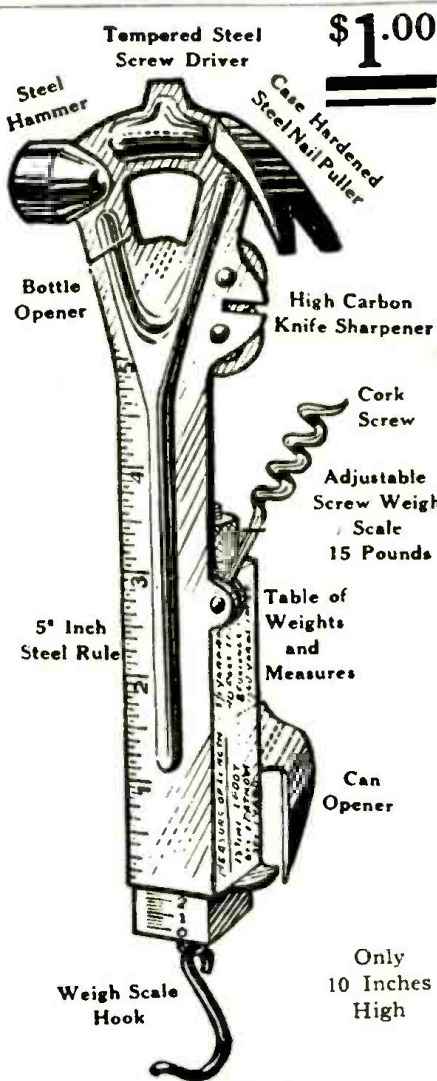

Mail
Coupon
Send for Yours
TO-DAY

soldered to the aerial by means of a small alcohol blow-torch, and well taped. All insulators used were of highly-glazed porcelain. The lead-in was then brought down diagonally across the court, to keep it well away from the wall; it was brought in by means of a lead-in strip, and taped up well to prevent corrosion of the clip. A wire, tested for continuity, replaced the lead inside to the set. The receiver worked a little better; and I then departed, satisfied that I had done a perfect job.

A few days later, the service manager informed me, the customer had just reported that the trouble had come up again and that, unless the job was completed, he did not want the set. I spoke over the phone to the customer, who said that it had rained the night before, and that he could now get only two stations. I hastened to the spot, and found his complaint well founded. A neighbor's receiver showed that there were plenty of stations on the air. The tubes were perfect.

I threw out fifty feet of loose wire in the room, and connected it to the set as an aerial. It brought in about seven stations, showing that the fault lay in the aerial installation. Running up the stairs, I inspected my job; everything was still shipshape!

I must admit that I had worked vainly on that job for about five hours when, suddenly, the stations began coming in, one by one, every ten minutes. I looked out of the window, and silently cursed that aerial, with every thought that can describe an aerial in uncomplimentary terms. Feeling myself beaten, I left the house, with the promise to return the next rainy day.

Three days later, I went back during a heavy rainstorm, and waited for something to happen. Sure enough, the stations began slowly fading out. I began at the set, and worked my way to the window. Here I tore up the lead-in strip and to my astonishment, WOR came in like a ton of brick. The metal weatherstrip was filled with a small pool of water at the base, and testing it, I found it grounded. That was the solution.

I punched a couple of holes in the metal weather strip to permit the water to drain off, and taped the lead-in strip well.

The customer was very much pleased (so was I) and offered me three brand new dollar bills. Last, but not least, the set stayed sold!

LONG-WAVE BROADCASTS

RADIO weather broadcasts, by voice, are now conducted on each even hour and half hour, for the benefit of aviation, on these long waves, from the following stations of the Department of Commerce: 855 meters, KDA, Maywood, Ill., and KDN, Rock Springs, Wyoming; 870 meters, WWO, Cleveland, O., KVM, North Platte, Neb., WEK, Wichita, Kas., and KKK, Reno, Nevada; 890 meters, KCQ, St. Louis, Mo.; 915 meters, KGD, Salt Lake City, Utah, and KCT, Glendale, Calif.; 935 meters, KRC, Kansas City, Mo., KSG, Cheyenne, Wyoming and KCV, Oakland, Calif.; 950 meters, KJF, Omaha, Neb., and KOJ, Elko, Nev.; 995 meters, WWQ, Bellefonte, Pa.; and 1,035 meters, WWU, Hadley, New Jersey.

Causes and Cure of Interference

(Continued from page 433)

of the building where the broadcast receiver is installed, the trouble should be traced down with the aid of an automobile and a portable loop receiver of good design.

An open car is to be preferred for this work; since the large amount of metal in a closed car body acts as a shield and "distorts" the graph "pattern" of the signal or interfering noises.

An Interference-Pickup Radio Set

Fig. 25 showed a schematic diagram of a regenerative receiver suitable for tracing interference. The circuit consists of a loop antenna, a regenerative detector, and two stages of audio-frequency amplification. Regeneration and oscillation are controlled by a .00015-mf. variable condenser.

There is nothing mysterious about this circuit. It is just a standard regenerative receiver using, instead of the common "three-circuit tuner," a "loop aerial" which combines in its design the action of an aerial, a primary, a tuned secondary, and a tickler winding.

The loop described possesses "directional characteristics"; that is, it will receive the greatest amount of signal energy when it points either toward or away from the source of the interfering signal. This idea is illustrated in Fig. 26.

When used in a large city, the loop may show limited directional characteristics because of the network of power, lighting, and traction feed wires resulting in deceptive indications. For this reason the location of interference is not accomplished by employing the directional characteristics of the loop, (as used on ships), but by what is termed the "intensity of signal" method.

Use of the "directional characteristic" of a loop is not generally accepted as the best

method for locating interference; because the loop will point to the nearest conductor which is carrying the disturbance, even though the actual source may be located miles away.

How to Use the Set

Starting from the building where the complaint is received, place the receiver in operation. Insert the headphone plug (which automatically lights the filaments of the tubes). Set the loop parallel with overhead power or lighting lines. Adjust the tuning controls for maximum intensity (which may at times seem to be of equal intensity for any adjustments of the controls). Now reduce the volume control until the signal is barely audible and, without changing the position of the loop, proceed for a short distance along the line which is suspected of radiating the interference. Take another reading; but this time reduce the volume if possible, in order to determine whether the source of interference is nearer. This procedure is continued until the volume control is reduced to its minimum setting. At this point the source of the trouble is usually found.

If the location seems to indicate that the trouble is on a particular pole, it should be shaken lightly in order to cause any loose wires or devices attached to it to vibrate. In this way poor connections will make themselves known by spasmodic and irregular sounds in the headphones.

If, at any time during the tracing of trouble, the filament or volume control has to be increased to make the signal or noise audible, it is an indication that the receiver is being moved away from the source and not toward it; hence the only course to take is to move the receiver in the opposite direction.

Makers of Radio---Guglielmo Marconi

(Continued from page 437)

Company; in December, stations were operating between the Isle of Wight and the mainland, over twenty miles. On June 3, 1898, Lord Kelvin, the veteran wizard of oceanic cable telegraphy, put down a fee for the transmission of the first paid radio message.

What others, even before Marconi had taken up his studies, had seen clearly, was the principle. What Marconi was working out with unbounded energy was the application—the creation of a transmitting and a receiving system, efficient and trustworthy. Marconi, developing the "aerial-and-ground" system, discovered the antenna characteristics required for selective operation. In April, 1900, his fundamental patent was issued.

Previously, however, the work of "wireless" experiment had been extended to the stage of ship operation where, obviously, it could fill a need not otherwise to be satisfied. Radio communication was established on a routine basis between the lighthouse service on land, at Dover, and the lightship

on the Goodwin Sands shoal, one of the danger spots of the English coast. On April 28, 1899, radio first saved lives by announcing the peril of a ship, the *R. F. Matheux*, which had collided with the lightship itself. This was the first of the thousands of dramatic events in which radio has averted tragedy.

In the summer of 1899, Marconi's apparatus was subjected to successful tests by the British navy; and, in the fall of that year, he visited America to give demonstrations which led to a qualified approval by the U. S. Navy, and to the organization in this country of the Marconi Wireless Telegraph Company, a subsidiary of the British organization.

In the following year, while commercial rivalry, tinged by national feelings, was arousing international competition for the Marconi companies, Marconi himself was busily working out the problem of portable equipment. He gave demonstrations from a steam-propelled automobile, in which a large sheet of copper served as his antenna,

"Here at last is **THE BOOK** that we of the Radio profession have needed for a long time. It is the best and most complete handbook ever published," says J. H. Bloomenthal, Chief Radio Operator, U. S. S. B. Steamship "East Side."

THE RADIO-MANUAL

A New Edition

Complete new chapters on aircraft radio equipment; Practical Television and Radiomovies with instructions for building a complete outfit; radio interference; 100% modulation; latest equipment of the Western Electric Co.; the Marconi Auto-Alarm System; and many other developments of the past year. All this information is added in the new edition and, besides, the entire book has been brought right up to date with much new material. *The Radio Manual* continues to be the one complete and up-to-the-minute handbook covering the entire radio field.



A Handbook for Students Amateurs Operators Inspectors

20 big chapters cover: Elementary Electricity and Magnetism; Motors and Generators; Storage Batteries and Charging Circuits; The Vacuum Tube; Circuits Employed in Vacuum Tube Transmitters; Modulating Systems and 100% Modulation; Wave-meters; Piezo-Electric Oscillators; Wave Traps; Marine Vacuum Tube Transmitters; Radio Broadcasting Equipment; Arc Transmitters; Spark Transmitters; Commercial Radio Receivers; Marconi Auto-Alarm; Radio Beacons and Direction Finders; Aircraft Radio Equipment; Practical Television and Radiomovies; Eliminating Radio Interference; Radio Laws and Regulations; Handling and Abstracting Traffic. An immense amount of information never before available, including detailed descriptions of standard equipment is presented.

Prepared by Official Examining Officer

The author, G. E. Sterling, is Radio Inspector and Examining Officer, Radio Division, U. S. Dept. of Commerce. The book has been edited in detail by Robert S. Kruse, for five years Technical Editor of QST, the Magazine of the American Radio Relay League. Many other experts assisted them.

Free Examination

The new edition of "The Radio Manual" has just been published. Nearly 800 pages, 369 illustrations. Bound in Flexible Fabricoid. The coupon brings the volume for free examination. If you do not agree that it is the best Radio book you have seen, return it and owe nothing. If you keep it, send the price of \$6.00 within ten days.

Order on This Coupon

D. Van Nostrand Co., Inc.,
250 Fourth Ave., New York.

Send me the Revised edition of THE RADIO MANUAL for examination. Within ten days after receipt I will either return the volume or send you \$6.00, the price in full. Radio-Craft 3-30

Name

St. & No.

City and State

STEP UP VOLUME ~ "REDUCES" STATIC

with Tunable Silver-Plated Aerial!

Clear, natural reception with interference reduced to a minimum is at last possible with SUB-TONE, the marvelous new TUNABLE SILVER-PLATED Aerial.

Less Static — More Selectivity

is achieved by tuning the aerial to the broadcast being received. Increases volume without increase in static.

SUB-TONE Works on All Sets

Not a wave-trap, filter or makeshift, but a combined aerial and tuner especially designed to meet the varied differences of construction in radio sets. Sub-Tone is tested and approved by experts.

TRY IT FREE!

BETTER RADIO PRODUCTS,
141 W. Austin Ave.,
Dept. 831-B,
Chicago, Ill.

Test SUB-TONE on your own set at our risk. Easily installed. Send coupon for interesting details and Free Trial Offer—TODAY.

Please send at once interesting details about SUB-TONE TUNABLE SILVER-PLATED Aerial and Free Trial Offer.

BETTER RADIO PRODUCTS
141 West Austin Ave.
Dept. 831-B Chicago, Ill.

Name
Address
City State

to the hotels which served as his temporary headquarters.

But, while a hundred or two hundred miles remained the limit of "wireless," it was obvious that the full possibilities of Marconi's system were not yet developed. The inventor erected a station, larger than any before designed, and took ship for St. Johns, Newfoundland. Here, on December 12, 1901, he sent up a kite carrying a temporary aerial line, and at half-past twelve in the afternoon (four o'clock, English time) heard the three dots of the letter "S" repeated again and again from the sending station at Poldhu in Cornwall, some two thousand miles away. The Atlantic had been spanned by radio! Within a few days more than a year, transoceanic communication had been opened between Poldhu and Glace Bay, Nova Scotia, between which official greetings from the governments of Great Britain, Canada and the United States had been interchanged.

It is not within the scope of this article to narrate the later history of the technical, the commercial and the financial development of radio; we may only say that Marconi, since the days of his more picturesque triumphs, has continued to work steadily and energetically in the application of scientific principles. His achievements, though bitterly contested by commercial rivals, met with the recognition of the world. Among the most cherished of the honors heaped upon him were those given by his own countrymen, including his fellow townsmen. In 1909 he was awarded the Nobel prize; in 1915 appointed by King Victor Emmanuel III to a seat in the Senate of Italy, a body of men chosen for life for their distinguished services.

In his earliest experiments, like his predecessors, Marconi had used ultra-short waves. Under the conditions of commerce, longer waves were found most dependable; and in the mind of most radio men, short waves were considered suitable only for the playthings of amateurs. Marconi, however, held fast to the idea of their utility; the fact that waves, as Hertz had shown, could be reflected, led to his development of a directional system, introduced in 1905. From this have been developed, first the "radio lighthouse," introduced by him on the English coast, near the scene of his early experiments; and later, the "beam stations," which focus their short-wave signals, like a searchlight, by "reflectors" composed of parallel wires behind the transmitting aeriels, and of which a great system now links the constituent nations of the British Empire.

For a number of years, Senatore Marconi has conducted a large proportion of his personal experiments in the elaborate laboratory with which he has equipped the yacht in which he takes extensive cruises. Here we may picture the great inventor, listening awhile to the merriment and melody of the continents, the hails and greetings of the sea, which is no longer silent and mysterious; and, perhaps, turning an attentive ear to the cries of a ship whose crew are being snatched from death by the instrumentality of the devices he has created. Here, then, we may leave him in the pride of past achievement, with the hope that he has much more to add to the creations which he has already made in the realm of radio.

HOTEL CENTURY

111 West 46th Street

Just East of Broadway
JUST COMPLETED
N. Y. City

350 ROOMS — 350 BATHS

This New Hotel contains every modern appointment

Every Room has Private Bath

\$3.00 per day up, Single
\$4.00 per day up, Double

Situated in the heart of the city; near Railway Terminals. All Leading Shops and Theatres within a stone's throw.

JAMES A. FLOOD, Resident Manager

Editor, SLOGAN CONTEST,
RADIO-CRAFT,
96-98 Park Place, New York City.

SEE PAGE 459
3-30

Gentlemen:

I have written below my entry in your \$100.00 Prize Slogan Contest.

Name
Occupation Age
Street Address
City State

Troubles in Mass Radio Production

(Continued from page 438)

fect becomes very serious during protracted periods of rainfall, when the humidity of the air measures nearly 100%.

It is not necessary to go into detail; but we may merely mention the well-known need for properly impregnating A.F. transformer windings and those of chokes and power transformers. In the power transformers and chokes, good impregnation is necessary in order to safeguard against breakdown under the high voltages encountered in these coils; while, in A.F. transformers, the main reason is to prevent electrolytic action. This, when moisture is present, eats away the wire, and soon results in an "open" coil.

Mass Production Problems

Another important cause of variations in receivers is a matter of design. For example, with a completely-shielded screen-grid tube circuit, the grounding system is of extreme importance. It is common practice to build receivers upon a painted chassis, the paint being scraped off where ground connections are to be made.

The difficulty with this practise is that it involves human frailties. When receivers are being made at the rate of a thousand or two thousand a day, it is evident that the man who is doing the "spot-facing" may miss one or more of the places to be spot-faced, in quite a few chassis. As a consequence, the ground connection at those points may or may not be good. If it is good at the factory, and passes the inspection tests, it may change during shipment, because of the jarring; and, when the dealer or customer gets the receiver, there may be no ground connection at all. The set then may either oscillate or be "dead." A good ground system is most important, in screen-grid sets, in order to prevent oscillation. On account of this, there is a growing tendency to use cadmium-plated chassis instead of painted, sprayed, parkerized or other surfaces which are non-conducting.

Another cause of difficulties, also a matter of design, arises in connection with the theory of "cause and effect." For example, there are many places in radio receivers, where small changes may produce large effects. We generally speak of such conditions as "critical." In neutralized circuits, for instance, in which things such as

inadequate shielding or grounding, or improper placement of parts occur, the effect may be such as to make the adjustment of the neutralizing condensers entirely too "critical." As a result, it is difficult to keep them in adjustment, when other changes which we cannot avoid are occurring; as for example, changes of tube constants with the strength of signal, regulation of the power supply, etc.

Again, in screen-grid sets, it is possible to obtain a stable condition by permitting the feed-back currents of the various stages to "buck" each other. This involves an incomplete grounding system; and it has been found that the receiver can be made stable with only a small amount (and corresponding reduced cost) of R.F. by-passing. The reduction of the cost is quite a temptation to use this method of attaining stability, but the method is more or less dangerous; since, if any of the few remaining ground connections become imperfect, the balance between the feed-backs will be destroyed and oscillation will result.

As another example, balancing schemes are often used in power-supply circuits, in order to keep the hum down. Some of these schemes work out very successfully; but others are not quite so successful, because of their critical nature.

And so we might go on and on, describing one trouble after another, for there are plenty. But you must not get the idea, from this article, that no commercial radio sets are any good. What we are trying to bring out is that, in large-scale production, there arise troubles of which the average radio Service Man is not aware, and which, quite often, do not really interest him. It is quite possible and practical to avoid all these difficulties but, unfortunately, things such as these are learned only through experience.

It is not possible, when building sets at the rate of a thousand or more a day, to hunt for these difficulties in every set; for this would involve an enormous labor cost and drive the price of the set sky-high. The remedy is to so design the set, and to adopt such practises in manufacturing, that such difficulties do not arise. It is not well to economize too rigidly. An ounce of prevention is worth a pound of cure, in radio manufacturing as well as in medicine.

New Developments in Short-Wave Radio

(Continued from page 445)

The possibility of adopting this method for amateur use does not imply insurmountable difficulties; for the antennas may be spaced as close as 1,000 feet or even less, and experiments have been conducted which show that two aeriols help materially in this work.

Screen-Grid Transmission

Technical developments in short-wave transmission have been numerous. Perhaps one of the greatest contributions to this phase of transmission is the development of the four-element or screened-grid transmitting vacuum tube. A problem which completely baffled engineers and hampered the

success of short-wave transmission has been the frequent "swinging" or changing in wavelength of signals, which made it necessary for the receiving operator to keep his hand constantly on the tuning control, in order to hear the signal continuously. This trouble has now been practically eliminated in the newest types of transmitters by the application to the system of transmitting of the screen-grid tube, which is primarily different from the ordinary three-element transmitting tube in that it contains two grids.

One is the regular control-grid, regulating the flow of electrons between the filament



993 pages
5 1/2 x 8 inches
fully
illustrated

Now available
as a complete
library—

Three books covering
the entire field
of building, repairing,
and "trouble-shooting" on
modern broadcast
receiving sets.

This Library serves alike the needs of the commercial radio dealer, installer and serviceman, and the amateur who keeps abreast with the latest trend in radio by building his own sets.

RADIO CONSTRUCTION LIBRARY

By JAMES A. MOYER

Director of University Extension, Massachusetts
Department of Education

and JOHN F. WOSTREL

Instructor in Radio Division of University Extension,
Massachusetts Department of Education

THESE three books embody not only a thorough home-study course, but a ready means of reference for the experienced radioician. Step-by-step information is given on wiring, "trouble-shooting," installation and servicing to get the best tone quality, distance and selectivity in broadcast reception in all types of sets.

Practical data is given on radio equipment such as antenna systems, battery eliminators, loud speakers, chargers, vacuum tubes, etc., etc.

A section is devoted to the identification of common faults in receivers and methods of making workmanlike repairs.

The three books are profusely illustrated with understandable diagrams of lookups, connections, loud speaker units, installation work and antenna erection—as well as numerous photographs, tables and charts which clarify the text.

See this Library for 10 Days Free
No Money Down — Small Monthly
Payments

It is your privilege to examine this Library for 10 days without cost. If they prove satisfactory, send an initial payment of only \$1.50 and \$2.00 a month until \$7.50 has been paid. Otherwise return the books.

McGRAW-HILL
FREE EXAMINATION COUPON

McGRAW HILL BOOK COMPANY, INC.
370 Seventh Avenue, New York.

You may send me the Radio Construction Library, three volumes, for 10 days' free examination. I agree to remit an initial payment of \$1.50 at the end of 10 days and \$2.00 a month until the price of \$7.50 has been paid—or I will return the books.

Name

Home Address

City and State

Position

Name of Company.....RC 3-30

EXTRA MONEY

IN YOUR SPARE TIME SELLING Ex Libris — Beautiful Bookplates



Definition from Dictionary:
(Ex Libris: from the books of—an inscription often printed on a card, called a bookplate, with the owner's name, and pasted in a book.)

Here is an opportunity for everyone, regardless of whether or not you have selling ability. You can make extra dollars in your spare time. Ex Libris (Beautiful Bookplates) sell rapidly and in large quantities—members of the family, friends and relatives will buy these bookplates without hesitating.

These artistic Duo-Tone Bookplates, illustrating old woodcuts and engravings are reproduced on antique-tint vellum paper, with name imprinted. They insure the owner against loss of cherished volumes and show the pride taken in a personal library.

Ex Libris (Beautiful Bookplates) sell at \$2 up per hundred with name imprinted. Write for our special profit plan of selling—or send 10c. for specimen and illustrated catalog of our unique series.

ISKOR PRESS, INC.

286 FIFTH AVENUE

Dept. 9

NEW YORK, N. Y.

1873 ^{NEW} in construction and furnishings--- 1930
OLD in hospitable traditions.



Famous for its home-like atmosphere. The SEASIDE is a rare combination of a thoroughly modern hotel and a great private home with your friends about you. The SEASIDE'S cuisine is famous; the porches and open and vita-glass enclosed sundecks invite you.

A few days spent here during the winter months will help you to keep fit in brain and body. The mildest weather north of the southern resorts, open golf throughout the year and no snow. Watch the reports of temperature of various cities and compare Atlantic City to them.

COOK'S SONS CORPORATION

The SEASIDE HOTEL

PENNSYLVANIA AVENUE AND BEACH
ATLANTIC CITY, NEW JERSEY

AGENTS WANTED

FREE BOOK. Start little mail order business. Hadwil, 27A-74 Cortlandt Street, New York.

3,000 VALUABLE FORMULAS, prepaid \$1.00. National Service, 3937 Marburg, Cincinnati, Ohio.

CHEMICALS

BOOKLET OF EXPERIMENTS and chemical catalog, 15c. General Chemical Company, Box 397, Reading, Penna.

DETECTIVES

DETECTIVES Earn Big Money. Excellent opportunity. Experience unnecessary. Particulars Free. Write, George Wagner, 2190B Broadway, N. Y.

INSTRUCTION

BE THE LICENSED RADIO DOCTOR of your community. Earn \$7.00-\$10.00 spare time evenings. Write now for free booklet. "Why the Radio Doctor?" Dept. C, 131 Essex Street, Salem, Massachusetts.

EARN TATTOOING. Instruction catalog, dime. Miller, N431 Main, Norfolk, Virginia.

OLD MONEY WANTED

\$5 to \$500 EACH paid for Old Coins. Keep ALL old money. Many VERY valuable. Get Posted. Send 10c. for illustrated Coin Value Book, 4x6. Guaranteed Prices. We buy and sell. COIN EXCHANGE, Room 10, Le Roy, N. Y.

PATENT ATTORNEY

PATENTS — Time counts in applying for patents. Don't risk delay in protecting your ideas. Send sketch of model for instructions or write for free book, "How to Obtain a Patent" and "Record of Invention" form. No charge for information on how to proceed. Communications strictly confidential. Prompt, careful, efficient service. Clarence A. O'Brien, Registered Patent Attorney, 343-A Security Bank Building (directly across street from Patent Office), Washington, D. C.

RADIO

POCKET RADIO. Clear Reception. Satisfaction GUARANTEED. \$2.00. Particulars FREE. Distributors wanted. Neil H. Tasker, South Sixth Street, Shamokin, Penna.

and the plate or anode of the tube; while the other serves as a shield or screen, and confines the field of electron activity. The purpose of the screen-grid is to protect the plate circuit from the capacity effects of the control-grid circuit and, *vice versa*, to protect the control-grid circuit. It does this while, at the same time, it allows electrons which are emitted from the filament to pass through the two grids freely and unretarded, unless the control-grid is made either positive or negative. It prevents feed-back inside the tube, permitting its use as a power amplifier in transmitting circuits. It protects the master-oscillator from capacity changes in the antenna. Its other advantage lies in the fact that it makes neutralization unnecessary.

Eliminating Recurrent "Hums"

Another important recent development in short waves relates more particularly to the receiving apparatus itself. This has to do with the receiving tubes used in the receiving set itself. How many of my readers have been troubled with unexplainable heterodynes, when passing over the very short waves? It has been found that these are often generated within the vacuum tubes themselves; not always in the radio-frequency amplifier and regenerative detector, but sometimes in the audio-frequency and power tubes of the set. And the coupling circuits (or tuning circuits) for this inherent oscillation that has troubled us for so long are the filament circuits! Especially when the circuits use A.C. tubes, and voltage balance is obtained by a potentiometer arrangement across the filament.

This has also been an explanation of some of the queer and unexplainable "hums" that have appeared when we tune down to the lower wavelengths. What actually happens is this: the resistors and wiring of the filament circuits may have enough inductive effect to produce a tuned circuit through the tube when the combined inter-electrode capacity is placed across it, through the plate and grid circuits. When the tuning circuits—proper—of the short-wave receiver are varied through the frequency bands occupied by these pernicious oscillations, a loud hum is heard in the telephone or loud speaker. It is interesting to note that the author discovered this effect on a long-wave receiver, some time ago, when investigating the complete frequency components of the radio-frequency and detector stages. Happily, the trouble can be easily remedied and any short-wave receiver freed from this trouble in a very simple manner.

In the accompanying diagram (Fig. 1) is shown the filament circuit of a type 27 heater tube with the usual potentiometer arrangement. The ordinary remedy would be to use what is termed a non-inductive potentiometer; but this does not seem to be entirely satisfactory, probably because the filament wiring may have the necessary inductance to cause resonance. The easiest way seems to be to shunt one side of the potentiometer winding with a large capacity that will tune the local oscillation away from the usable short waves. It has been found that a capacity of from .005- to .01-mf. is sufficient to raise the wavelength out of the short-wave spectrum; and then all recurrent hums and heterodynes disappear and cause no further trouble.

This is something that the regular Service

Man and professional set builder will do well to keep in mind on his short-wave receivers when trouble of this kind makes its appearance, as it almost always will. The corrected circuit arrangement is also shown with the by-pass condenser (Fig. 2).

And so we can see that it is not only in the big things that short-wave radio is progressing. Many of the most important developments in this field are seemingly little details, unobtrusively accomplished in the great and small laboratories of the world by painstaking labor and tedious research. Thus it has been with the quick development of the short waves from the plaything of amateur experimenters—to whom

a large portion of the final results must be accredited—to many systems of communication and control which promise to bring every spot on earth within calling distance.

(In the April issue of RADIO-CRAFT, Mr. Cockaday will continue his description of the newest developments in short-wave radio reception and transmission, with special reference to transatlantic communication, both point to point correspondence and broadcasting, which is making it possible to hear European programs in this country. He will deal also with the remarkable extension of radio facilities in aviation, one of the most striking developments of the past year.—Editor.)

Short-Wave Transmitter Design

(Continued from page 449)

filter, and gives excellent results if properly operated. The solution, once the plates have been formed, will last for several months. The distilled water is decomposed by chemical action and evaporates; so that the water must be replenished. The evaporation may be greatly reduced by the use of a thin film of some heavy oil on the surface of the solution. Ordinary animal or vegetable oils are "emulsified" by borax and will not serve; paraffine oil is good.

Rectifier leads should not be run near the transmitter; all sorts of peculiar frequencies are set up in a sparking rectifier and these often "modulate" the transmitted frequency, giving a very broad signal. These frequencies, also, may find their way into the A.C. lines and cause trouble in general. Rectifiers will often spark when working in spite of all one can do; placing the rectifier in a well-shielded case containing the filter will eliminate this trouble. The shield should be grounded. Ordinary wire netting used as a shield reduces the interference greatly. It should be remembered, however, that sparking is no sign that a rectifier is operating properly; and, for best results, use enough jars so that the voltage across each jar does not exceed about thirty.

There are two connections for rectifiers in common use; these are shown in Figs. 5 and 6. The bridge system, shown in Fig. 6, requires no tap on the transformer and is the more convenient of the two.

When a rectifier is new it offers very little resistance to the passage of current and so, when first connected, it may cause the transformer to heat. The primary transformer current should be cut down to a low value by using a ballast resistance, such as a jar of salt water, connected in series with the line. As the rectifier forms, the distance between the electrodes in the salt solution may be reduced and finally the jar may be removed. Use a large jar with plenty of the solution, and see to it that the transformer is not heating.

Experiments indicate that chemical rectifiers fail to function when the solution becomes heated; consequently plenty of plate surface should be allowed for a given current. The following table gives convenient data, which may be used in rectifier design. For intermediate voltages and currents, use intermediate values:

RECTIFIER DATA

Plate voltage	Aluminum and lead plate areas	Total jars (Bridge connection)
350	1½ sq. in.	24
500	2½ "	32
750	3 "	48
1000	3½ "	60

These values allow plenty of surface for overloads. One may, of course, originally design the jars so that any voltage up to 1000 may be used by adding the required number of jars.

Filtering the Plate Supply

All sorts of filters are suitable; but a system which works well comprises a large choke, in series with the positive side of the transmitter input, and a condenser connected directly across the plate supply on either side of this choke. Ford coil secondaries will serve, but their resistance is high; two or three of them connected in parallel will give good results. The coil vibrators should be screwed down, and the primaries left unconnected. The condensers, of course, must withstand the plate potential and, the larger their capacity, the better.

For general use, an arrangement which will give satisfactory results is shown in Fig. 7. With the known plate voltage (as given by the manufacturer) that is to be used, find the number of jars and plate area from the accompanying table, and construct the rectifier. (Notice that it is necessary to have the number of jars divisible by four; so they may be conveniently arranged in the bridge.) Arrange the jars in a box, which may be shielded, as described, allowing room for the filter; the capacity of the condensers will depend upon the number available. Use commercial borax, and put enough in the distilled water so that some remains at the bottom; that is, make a saturated solution. Pour in the clear solution and "form" the rectifier as described; a "forming" circuit is shown in Fig. 8. The power may now be connected to the oscillator, the positive lead going to the plate.

An efficient oscillator of constant frequency, a well-rectified, well-filtered, plate supply, and a good antenna system, allow one to enjoy Amateur Radio.

Read what engineers have to say about Rider's "Trouble Shooter's Manual"

RADIO CORPORATION OF PENNSYLVANIA
331 Fourth Avenue
Pittsburgh, Pa.

August 23, 1929.

Radio Treatise Co.,
1440 Broadway, New York City.
Gentlemen:

We have received John F. Rider's "Trouble Shooter's Manual" which our instructors, who are Westinghouse Electric and Manufacturing Company and Radio Corporation of America engineers, recommend highly and say that all of our radiotrician students should have a copy.

Very truly yours,
Radio Corporation of Pennsylvania,
(Signed) W. R. Jones,
Business Manager.

Is a higher recommendation possible? You too, if you are interested in radio and radio service will find Rider's

"TROUBLE SHOOTER'S MANUAL"

of infinite value. Wiring diagrams of more than 200 models of radio receivers . . . Trouble Shooting information . . . How to find the trouble . . . The possible troubles and symptoms in radio frequency amplifiers—detectors—audio frequency amplifiers—A eliminators—B eliminators—a wealth of vital money-making information . . . THE BOOK WILL BE WORTH HUNDREDS OF DOLLARS TO YOU . . . 22 chapters of vital information—the kind of dope you need in your service business . . .

Wiring Diagrams of These Commercial Receivers

- | | |
|----------------------|-------------------|
| Radio Corp. of Amer. | Federal |
| Atwater-Kent | Crosley |
| Zenith | Majestic |
| Fada | Stromberg-Carlson |
| Stewart-Warner | Grebe |
| Philco | Freshman |
| Freed-Eisemann | Kolster |
| All-American | Day-Fan |
| Colonial | Workrite |
| Amrad | Sparton |
| DeForest | Ware |
| Garod | Kennedy |
| Operadio | Sleeper |
| Magnavox | Grimes |

240 PAGES 8½" x 11", BLACK STURDITE BINDING

RADIO TREATISE CO.
1440 Broadway, New York City
Send No Money

RADIO TREATISE CO.,
1440 Broadway, New York City.

Send me John F. Rider's "Trouble Shooter's Manual" and I will pay postman \$3.50 plus a few cents for postage on delivery. It is understood that if I do not find the book satisfactory after 10-day examination, and the book is returned in good condition, my money will be refunded.

Name

Address

City..... State.....

SKINDERVIKEN Transmitter Units

95¢

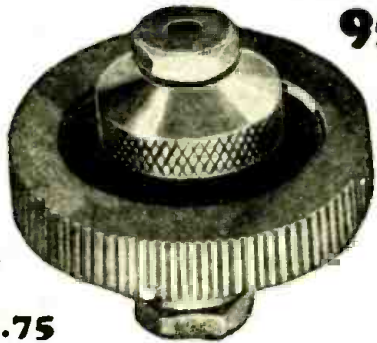

Two for \$1.75

Have hundreds of uses. Every amateur should have two or three of these amplifiers in his laboratory

A FEW USES FOR THESE UNITS

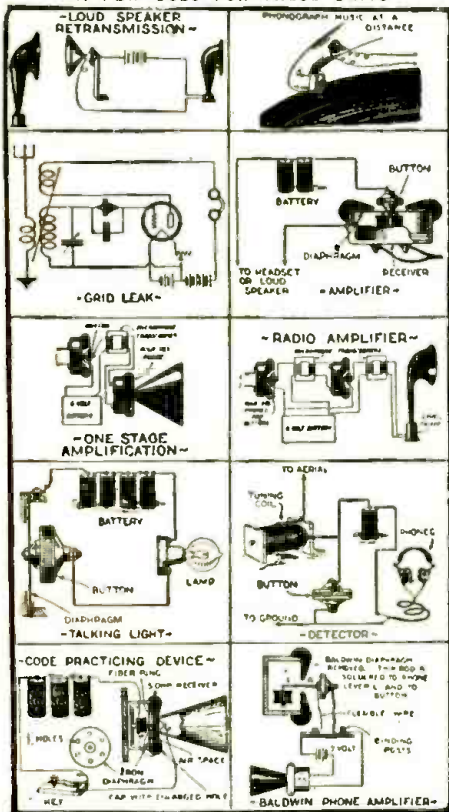

12-PAGE INSTRUCTION BOOKLET

containing suggestions and diagrams for innumerable uses, furnished with each unit.

WE PAY \$5.00 IN CASH

for every new use developed for this unit and accepted and published by us.

P. G. Microphone Transformer



A Modulation Transformer specially designed for use with the Skinderviken Transmitter Unit. Has many other uses. Primary resistance, 12 ohm; secondary, 55 ohms.

\$2

FOR SALE AT LEADING DEALERS Or Order Direct, Using Coupon Below

SEND NO MONEY

When the postman delivers your order you pay him for whatever you have ordered, plus a few cents postage.

PRESS GUILD, Inc., 16-18-R—East 30th St., New York, N. Y. R-3-30

Please mail me at once as many of the following items as I have indicated.

... Skinderviken Transmitter Units at 95c. for 1; \$1.75 for 2; \$2.50 for 3; \$3.20 for 4.

... P. G. Microphone Transformers at \$2.

When delivered I will pay the postman the cost of the items specified plus postage.

Name

Address

City..... State.....

Locating Hum

(Continued from page 412)

A large leakage current causes rapid deterioration of the condenser and ruins the operating efficiency. Now, in connection with this action, we must state that a certain form of satisfactory operation is secured at the start, even though the value of leakage current is greater than normal. However, as the period of usage lengthens the detrimental effect of the leakage current manifests itself and the unit becomes unfit for further use. This explains the reason for unsatisfactory performance after a period of operation, a close observer will note that the percentage of hum, as discerned by the ear, increases gradually until it becomes decidedly annoying.

It is possible that the hum is not due to a defective rectifying element or a defective filter condenser. Instead, it may be due to an open in the circuit connections between the filter condensers and the remainder of the circuit. An open in the rectifying element or in the circuit between the rectifying element and the filter chokes, or at some point carrying D.C., would be evidenced by failure of the complete unit; since the path of the D.C. current and voltage would be open. We have experienced failure of filter condensers more frequently than an open in the circuit of a defective rectifying element.

To determine if the hum is in the "A" eliminator, it is necessary to replace the eliminator with a storage battery. If the hum disappears with the battery supply, the hum is in the eliminator. Replacement is the only remedy.

The Cooperative Laboratory

(Continued from page 459)

Automatic Coupling Systems

Other arrangements, too, have found their way into commercial production and then almost as promptly disappeared again. Among these were the variable-coupling systems known by the names of some of the men who sponsored them. Some of you will recognize the names of Lord, and of the King or the Karas "Equanatic." Some of the early Zenith receivers employed a variable coupling system; and one of the rather recent Hammerlund-Roberts circuits utilizes a similar idea. The variable coupling was usually obtained by a mechanical contraction appended to the rotor shaft of the condenser; so that the primary was brought into closer relationship with the secondary coil at the long wavelengths. When the ganged tuning condenser became a necessity, the mechanics of a variable coupling became too complicated and costly. It fell by the wayside.

It would not be fair to pass from this subject without mentioning the so-called Loftin-White circuit, designed to accomplish equal R.F. amplification over the broadcast band. The essentials of this are shown in Fig. 7; it is apparent that it comprises a combination of inductive and capacitive coupling wherein the deficiency in gain on the long waves, due to inductive coupling, is offset by a gain in coupling at the long waves

A Special Courtesy to

Radiotricians
Professionals
Engineers
Mechanics
Consultants
Designers
Service Men
Contractors
Manufacturers
Dealers

IN ORDER to make it possible for all Radio Technicians to read RADIO-CRAFT regularly, each month, we have put into effect a special subscription price.

The regular price of RADIO-CRAFT is \$2.50 per year (12 issues). The newsstand rate is 25 cents a copy.

Any radio professional, sending in a subscription on his letterhead, showing that he is engaged in some capacity in radio work will receive as a special courtesy

EIGHT ISSUES OF



FOR ONE DOLLAR

Just pin a dollar bill to the coupon below and forward it with your letterhead or business card.

RADIO-CRAFT, RC-3, 98 Park Place, New York, N. Y.

Enclosed find \$1.00 for which please enter my subscription to RADIO-CRAFT for next eight months.

Name

Address

City..... State.....

through the condensers C. Some of the first attempts to commercialize this did not meet with overwhelming success; but the idea looks good, and we should see more of this in the future.

Now, all of this has been leading up to something. These articles of research are never compiled with only an historical motive; records of past performance are extremely necessary, to indicate an intelligent procedure for the future. The circuit which we wish to propound was first used in a variation of the Inverse Duplex (disclosed in *QST* Magazine some time ago)

but, until now, has never been worked out to apply to a straight radio-frequency circuit.

This idea produces almost equal R.F. amplification at remarkable selectivity; it is a circuit wherein the gain on long waves is obtained by automatic regeneration, obtained through a simple electrical filter. There is nothing complicated about it. The bare elements are shown in Fig. 8; for the time being, we have chosen to call this the "Filter Feed-back" circuit.

The next issue of *RADIO-CRAFT* will give more information on this interesting circuit.

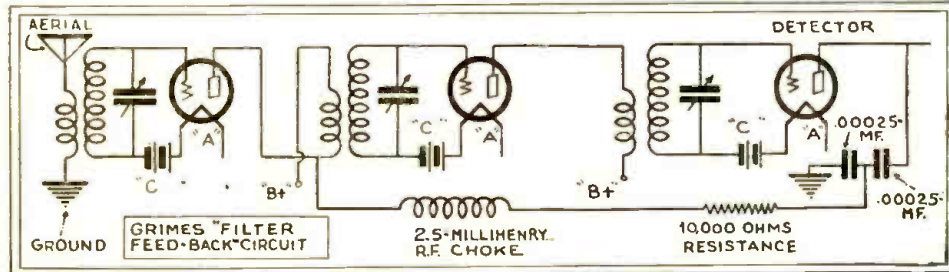

Fig. 8

Here we have the circuit propounded by Mr. Grimes, which equalizes the amplification by regenerative feed-back through the capacity, resistance and inductance shown. Details of its operation will be given next month.

Reception with a Radiovisor

(Continued from page 451)

ular with the problems of working weak and fading short-wave signals.

A receiver with a sensitivity of 100 microvolts per meter will probably be more satisfactory than one of greater sensitivity, because of its lowered susceptibility to inductive interference. To those not familiar with comparative sensitivities as expressed in terms of microvolts per meter, it may be explained that the present-day broadcast receiver with screen-grid tubes has a sensitivity of about 10 microvolts per meter, or ten times that recommended for the radio-visor receiver.

(In fact, some of the latest radio sets achieve a "sensitivity" of 1 microvolt; or 100 times the pick-up recommended for good picture reception.—*Editor*.)

Another source of poor results with radio-visor may be traced to the audio amplifier output. Experimenters have been working with the 71A power tube; yet we have found that the output of such a tube, namely, 0.7-watt, is insufficient to operate properly the usual neon lamp. The 45 type power tube is essential.

The usual neon lamp requires 1.5 watts of undistorted input for good response. The voltage of the output circuit should be around 200 volts D.C.; the A.C. signal about 50 volts R.M.S. on the neon lamp proper.

Scanning Disc Faults

The scanning disc is another source of poor results. Most of the scanning discs now available are inaccurate; that is to say, the holes are badly located, so that they fail to weave a satisfactory pattern of horizontal, closely packed, luminous lines. Many of the discs are not mechanically true and therefore, wobble, causing further distortion of the image. A scanning disc or drum should be made with watchmaker's precision. The holes must be laid out on an "engine

lath." The inexpensive discs, which have been available on the market in the past, are hardly satisfactory for good radio-visor pictures. The advanced experimenters have even gone to the extreme of having their discs made in Switzerland, by skilled machinists accustomed to precision work.

The accuracy of a scanning disc can be readily checked. If the neon lamp is fed with unmodulated or pure D.C. (such as that from batteries) and the disc is rotated, there should appear a more or less solid and glowing pattern. If black streaks appear, it is certain that there are inaccurately-placed holes in the disc.

Maintaining Synchronism

Another source of poor results is the driving motor. Obviously, to weave a satisfactory pattern, the scanning disc's speed must correspond to that of the transmitter. It must be in step, or in perfect synchronism. For the present, the simple expedient of "synchronous" motors, operating on the same A.C. power system, is depended upon to keep receiving and transmitting scanning systems in step.

Even with a synchronous motor and the same power system, it is often necessary to "frame the picture" in the vertical and horizontal planes. The vertical or up-and-down framing, necessary when portions of two pictures appear one above the other, is accomplished by snapping the motor switch one or more times. The horizontal, or left-to-right framing, is achieved by shifting the neon lamp's cover, or the motor frame, to alter its relationship to the scanning disc or drum.

Where the receiver is (a) on a different power system than the transmitter, or (b) must be operated on direct current, or (c) with a battery motor, it becomes necessary to employ electrical or mechanical synchronizing means, manually operated. A variable-

MAKE GOOD RECEPTION EASY



Thousands of users marvel at the difference in reception with a Townsend "B" Power Unit. Full, sweet tone, clarity, volume and greater distance are among the many advantages reported daily.

ONLY \$3.85 COMPLETE

TOWNSEND "B" POWER UNIT

Hooked up in a few minutes; just plug into the light socket and forget it. Delivers up to 100 volts on any set—D.C. or A.C.—any cycle.

Approved and passed by the rigid laboratory tests of "Popular Radio" and "Radio News."

Over 150,000 Now in Use!

There's no longer any reason for putting up with the expense and un dependable performance of "B" Batteries—when you can own a good "B" Power Unit for \$6.85. Over 150,000 Townsend "B" Power Units now in use—a substantial proof of satisfaction.

Send Only \$1.00

Send name and address with only \$1.00. On arrival of Townsend Power Unit pay postman \$5.85 plus postage. Try out ten days, then, if it fails to do everything we say, return it and money paid us will be refunded. Make a REAL receiver of your set.

PROOF

Your Eliminator brings my T-tube Atwater Kent right up with any electric set in this neighborhood.

E. W. Carter, Norwich, Conn.

Your Eliminator has given constant service for two years. Can get practically anything with it that friends with high powered A. C. sets have difficulty in bringing in.

F. W. Schmidt, Jr., Jacksonville, Fla.

TOWNSEND LABORATORIES

723 Townsend St. Chicago, Ill.



AUTOMATICALLY!

AMPERITE automatically regulates radio tube voltage. Lengthens tube life. Essential with eliminators. Insist on AMPERITE. Nothing else does AMPERITE'S work. \$1.10 with mounting (in U. S. A.) at all dealers.



This symbol in a radio diagram means—

AMPERITE Corporation 561 BROADWAY NEW YORK

FREE—"Amperite Vest Pocket Tube Chart." Write Dept. RC3.

AMPERITE The "SELF-ADJUSTING" Rheostat

FREE! RADIO BARGAIN CATALOG ALSO FREE RADIO GIFT

Send now for this new free radio catalog which saves you many dollars on radio outfits, kits, parts, tubes and accessories! Also TIME CONVERSION CHART FREE Tells you instantly what time it is in any part of the world! Given free if your request for catalog reaches us this month.

20TH CENTURY MAILORDER CORP. 202 JACKSON ST. CHICAGO, ILL.

Genuine PILOT Parts

Philadelphia
Your Choice Should Be
The
HOTEL MAJESTIC
BROAD ST. AND GIRARD AVE.

400 Large Rooms

Only Hotel in Philadelphia with a subway entrance from main lobby

Most Moderate Rates!

Single Room, running water...\$2.00
For Two\$3.50
Single Room, private bath...\$3.00
For Two\$5-\$6

Garage Connected with Hotel

Wire at our expense for reservations

JNO. C. GOSSLER, Mng.-Dir.



Orders - Inquiries

60 pages
Send for FREE Copy
Can be Secured by MAIL

POLK'S REFERENCE BOOK and Mailing List Catalog

Gives counts and prices on over 8,000 different lines of business. No matter what your business, in this book you will find the number of your prospective customers listed. Valuable information showing how to use the mails to secure orders and inquiries for your products or services is given.

Write for FREE Copy
R. L. POLK & CO., Detroit, Mich.
Largest City Directory Publishers in the World. Branches in Principal Cities
Mailing List Compilers—Business Statistics
Producers of Direct Mail Advertising

WE MATCH PANTS To Any Suit!

Double the life of your coat and vest with correctly matched pants, 100,000 patterns. Every pair hand tailored to your measure; no "ready-mades." Our match sent FREE for you O. K. before pants are made. Fit guaranteed. Send piece of cloth or vest today.
SUPERIOR MATCH PANTS COMPANY
115 So. Dearborn Street. Dept 374, Chicago

I CHALLENGE

you that I will teach you, by mail, in one lesson, the simplest, shortest method all for \$1.00. Not telepathy. You can read one's mind to a dot, by only looking in the eyes of partner, chum, sweetheart, etc. Praised by New York, Boston, Montreal Police Chiefs; colleges; Thurston, Blackstone, etc. If fake, let them arrest me.
A. HONIGMAN, Dept. RC-3, 5116 Clarke St., Montreal, Canada

speed motor with variable-speed control and push-button accelerator (short-circuiting the series resistance in the motor's supply line), or again a *friction drive* that can be moved away from the center shaft of the free-turning scanning disc, may be resorted to.

The neon lamp is a further source of failure. Many poor neon lamps which either fail to glow uniformly over their entire plate surface, or are insensitive to current changes or modulation, have appeared on the market.

What Are the Tests for "Detail"?

With the foregoing considerations noted, the question arises what constitutes good television reception? As in sound broadcasting, it is difficult to discuss comparative merits in the absence of quantitative standards.

In our Jenkins transmission and reception tests, we have certain standard photographic films, in which the reproduction of various details serves as a gauge of the degree of fidelity we obtain with different apparatus and arrangements.

Thus, in our "Big Fight" silhouette film frequently broadcast, we watch for the ropes of the ring. If these ropes appear, we are satisfied with the detail; even with a relatively poor receiver and radiovisor, the ordinary figures show up well. Interference appears as clouds in the background. A faulty scanning disc or drum shows up as a streaky picture.

In our half-tone pictures, such as a close-up of the human face, even a poor receiver and radiovisor will give a fair outline of the face and will depict the hair; if transmission and reception are good, the eyebrows, eyes and mouth can be made out. If conditions are ideal, the mouth and even the detail of the teeth are represented.

Great stress has been laid on pictures of smoke issuing from a man's mouth or from a lighted cigarette. Smoke, as a matter of fact, televises well; so that this feature is no indication of good radiovision results. Also, moving objects are popularly looked upon as difficult to reproduce; whereas the opposite is true in practice. A still object becomes conspicuous and separates itself itself from the background only when it begins to move. It is the still objects that usually lack detail.

In our laboratory work, we have developed a "cone design," made up of a number of stripes which taper to a point at the top (Fig. 1). By scanning such a design from the base to the apex, it becomes possible to test the frequency cut-off of the transmitter and receiver. At first, we could go only about half way up the cone; when the lines would simply be solid black from that point up to the apex. Today, we go nearly up to the apex, with the small remaining portion in solid black.

MARCONI'S ANNIVERSARY

ON December 12, the twenty-eighth anniversary of his first radio reception across the Atlantic, Senatore Guglielmo Marconi broadcast a description of his experience through the short-wave station G5SW (which is in the Marconi works at Chelmsford, England) for the benefit of American listeners. The address was picked up by many short-wave listeners direct; as well as rebroadcast by stations for the regular broadcast audience.

NOW On All Newsstands

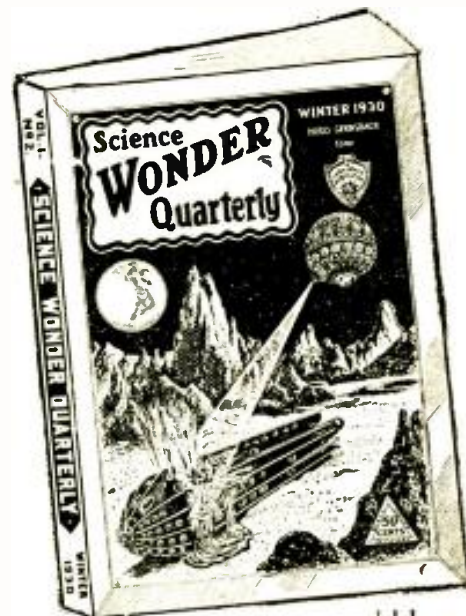

144 PAGES
4-COLOR COVER

THE MOON CONQUERORS

By R. H. Romans

Mr. Romans is a modern Jules Verne and his story of two planets will undoubtedly rank with the "Shot Into Infinity" as one of the best interplanetary stories of recent years.

AMONG THE OTHER STORIES ARE:

INTO THE 28TH CENTURY

By Lilith Lorraine

THE OSMOTIC THEOREM

By Capt. S. P. Meeks,
U. S. A.

The subscription price of the QUARTERLY is \$1.75 per year, single copy 50c.

To new subscribers, a special price of \$1.25 per year is now available. This offer will positively be withdrawn after March 1, 1930.

50c The Copy
On All Newsstands
or mail coupon



SCIENCE WONDER QUARTERLY,
Dept. RC-3, 98 Park Place, New York, N. Y.

Enclosed please find \$1.25 for which send me the next 4 issues of SCIENCE WONDER QUARTERLY. (Canada and foreign \$1.50.)

Name

Address

City..... State.....

The Inventor and His Patent

(Continued from page 451)

The following dates were copied from five patents selected at random from the issue of the year 1927:

Filing Date	Date	Time
May 9, 1922	Apr. 5, 1927	1 yrs. 11 mo.
Apr. 7, 1922	same	5 0
Aug. 3, 1922	same	4 8
Feb. 18, 1921	same	6 2
Feb. 15, 1926	same	1 2
	Total	20 23
	Average	4 4.6

The average arrived at in this way, in round numbers 4 years 5 months, closely approximates Senator King's average, 4 years 6 months.

The variation in the "prosecution times" of different patents is indicated by the different periods for the foregoing examples.

The average time of prosecution changes and, in general, increases from year to year. Around 1927 the time of prosecution probably was longer than any prior time in the history of the Patent Office. Early in that year, a drastic step was taken to reduce the period by cutting the permissible time for responding to an Office action from 1 year to 6 months.

What is the probability that a patent will be obtained after it has been applied for?

The answer to this question is decidedly an approximation. The report for but one year has been investigated, 1925; this contains a list of applications and patents granted on those applications from the year 1840. A rough approximation shows that at no time has the ratio of patents granted to applications filed been greater than 75% or less than 44%. In general, the ratio does not greatly vary from 50%; the probability that a patent will be obtained after it has been applied for is "fifty-fifty." In other words, of two applications filed, one will mature into a patent.

In general, what is patentable?

The Revised U. S. Statutes instruct the Patent Office that arts, machines, manufactures and compositions of matter are patentable. One may call these "contrivances", if he so wishes; or one may call them "conceptions emanating from the mind." Most people prefer to call them "inventions."

One prerequisite must first be present before one of these inventions is patentable—*newness or novelty.*

What is an invention?

This question may be revised to read: "What kinds of physical objects and processes may be called inventions?"

*** an invention ** is something practically utilizable in an industrial art ** (Roberts on Patentability of Inventions and Interpretation of Patents, V. 1, p. 3)

"An invention consists of an integral group of cooperant instrumentalities, each of which performs one or more functions which unite with functions performed by all the other cooperants to produce conjointly an industrially utilizable resultant?" (Roberts, V. 1, p. 249)

All of which leads, more or less, to the definition that an invention is a combination

of instrumentalities or elements. A step in a method, a chemical in a compound, a lever in a machine, or a lens in a camera—these are instrumentalities.

A mere aggregation, such as an assortment of pencils, is not a combination and cannot be made the subject of a patent under ordinary circumstances. However, a pencil with a lead-feeding means on it may be a combination, and may be made the subject of a patent.

Inventions must have commercial value.

The industrial connotation of patents should not be omitted. While not necessarily intended for consumption by industry an invention should be utilizable by industry. That is, an invention should have some commercial significance; unadorned scientific discoveries cannot be made the subject matter of a patent. (An optional definition of invention is that it is the proper subject matter of a patent.)

Is a model required?

The answer is "No;" but this should be qualified by the statement that rarely, the Patent Office does call for a model.

How long does a patent run?

The statutory period is 17 years.

Can it be renewed at the end of that time?

At the end of 17 years the patent monopoly has expired, and the invention belongs to the public. As a rule, no extension of time is permitted. Extensions which, under certain circumstances, are granted to World War Veterans form the only exception to the rule.

What is a patent?

"A patent is the grant by the government of a seventeen-year right to exclude others from making, using or selling anything which the courts may hold to be within the purview of any one of such claims of the patent as may be held to be valid." (Hoar, Patents, p. 11.)

How many patents are there in the Patent Office?

U. S. Patent Number 1,712,478 is listed in the Official Gazette of the U. S. Patent Office, May 7, 1929. In addition to U. S. Patents, the Patent Office has a vast number of foreign patents; 2,000,000 is a conservative figure.

How many applications for patents are filed in one year, in the Patent Office?

During the fiscal year ended June 30, 1927, the applications for patents, reissues, and designs totalled 89,360. (Annual Report of the Commissioner of Patents, 1927, p. 7). The business of the Patent Office, together with the business of the industries of the country, is on the increase.

How many applications are now before the Patent Office awaiting action?

95,000 (Senator King in the Washington Post, Apr. 22, 1929).

How much space is required to hold all the patents in the Patent Office?

A hundred and twenty miles of shelving. Does American industry depend upon patents?

The New York Times has estimated that nine-tenths of American industry has sprung from patents.

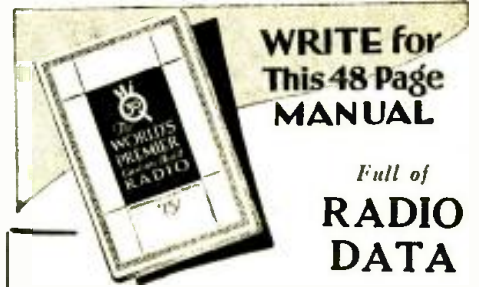

Useful to the CUSTOM-BUILDER and ADVANCED FAN

Describes the newest and finest
BAND-FILTER TUNING
—SCREEN-GRID AMPLIFIER — PUSH-PULL
POWER AMPLIFIER —
POWER PACK — UNIT
CONSTRUCTION — EF-
FECTIVE SHIELDING—
SPEAKERS — CABINETS
— INSTALLATION
— SERVICING.

It will make money for you; it will save money for you.

Write for it today.

Use the convenient coupon.

Hammarlund-Roberts, Inc., Dept. R.C.3,
424-438 W. 33rd St., New York.
Enclosed 25c (stamps or coin) for "HQ-30" Manual.

Name.....
Address.....

No Wind Can Blow It Out

MAKE UP TO \$40 A DAY

Showing My Mystery Lighter to Men. What Makes It Light! All Guaranteed. No Flint or Friction. New Principle of Ignition. Sample with Sales Plan, 25c. Sample Gold or Silver Plated, \$1.00. Agents write for proposition.

NEW METHOD MFG. CO.
Desk SF-3, Bradford, Pa.

Write for Information about the NEW
H-F-L MASTERTONE
LABORATORY MADE RECEIVER
The Year's Outstanding
Radio Achievement
HIGH FREQUENCY LABORATORIES
28 N. Sheldon St. Dept. 74 Chicago, Ill.

LEARN RADIO
in a school with a reputation for graduating competent men
Dormitory - Laboratory - Workshop
Subjects Taught
Navigation Radio Commercial Radio
Radio Service Radio Broadcast
Laboratory Vitaphone-Mastertone
Radio Mathematics

Write for further information

COMMERCIAL RADIO INSTITUTE
38 W. BIDDLE ST. FOUNDED 1920 BALTIMORE, MD.

NEW
BISMARCK HOTEL

RANDOLPH AT LA SALLE
YOUR VISIT TO CHICAGO

Will be a pleasant memory if you select the right hotel. The New Bismarck welcomes you to a hostelry where good food, superior service and cheerful comfort await you.

Easily accessible to all the high spots of the city.

Rooms, \$2.50 and up—
With Bath, \$3.50 and up

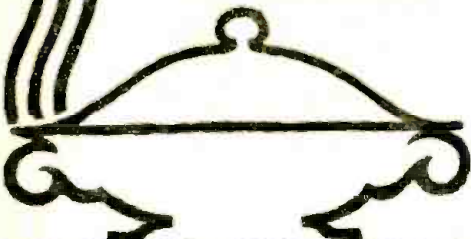

CHICAGO

PATENTS

Protect Your Ideas

Write for Instructions, free on request - - or send drawing or model for preliminary examination of Patent Office records

Promptness Assured with Best Results

Carl Miller
PATENT ATTORNEY

Former Member Examining Corps, U. S. Patent Office
265 McGILL Building, Washington, D. C.

SONG WRITERS!

Substantial Advance Royalties are paid on work found acceptable for publication. An one wishing to write either the words or music for songs may submit work for free examination and advice. *Paste experience unnecessary.* New demand scribed in our free book. Write for it today—Newcomer Associates
751 Earle Building, New York, N. Y.

When it comes to making sick radios well, or good radios better just

Remember **CLAROSTAT** for Every Purpose
there's a

For literature, write CLAROSTAT Mfg. Co.
295 N. 6th St., Brooklyn, N. Y.

Service Man's Forum

(Continued from page 436)

when the surge comes have him put a milliammeter in the plate circuit, and watch the meter when the filament switch is opened. A six-ohm rheostat will replace the switch nicely, and eliminate burn-outs if we match the resistance of the transformer primary with the plate resistance of the tube.

As I have not made enough money at radio servicing to be intimately acquainted with the Florida state, however, it may be I can sell Mr. Merwin enough rheostats to pay him a visit in the near future.

S. M. SMITH,
41 Benedict Ave.,
Valley Stream, L. I., N. Y.

Radio-Craft Kinks

(Continued from page 460)

house, which eliminated outside pick-up, is shown in Fig. 4. For maximum efficiency and where space permits, a more elaborate counterpoise system can be adopted as illustrated in Fig. 5.

USING THE BROKEN RULE

By E. E. Youngkin

ALMOST every workman has around his shop a "collapsible" rule that has seen better days. In Fig. 3 is shown a double section of such a rule, fastened to the end and lid of a cabinet to hold the lid open. A metal angle is used to pivot one end of the rule-section to the hinged lid.

Radio Book Review

USING RADIO IN SALES PROMOTION, by Edgar H. Felix. McGraw-Hill Book Co., New York. 5 3/4" x 9", illustrated, xii, 386 pages. Price \$5.00.

This volume, the first to deal with its subject systematically and thoroughly, is a landmark. The advertiser who is venturing into a field unknown to him is indeed fortunate to find such a guide. At this time, when the uses of broadcasting, to reach the listener more intimately than can any other form of general salesmanship, are being increasingly appreciated—and the necessity of profitable advertising appropriations to maintain the high quality of programs demanded by the listener is also startlingly apparent—Mr. Felix's book is worthy of reading by business men and students, even outside of the professional field of broadcast advertising. The radio engineer, designing a commercial receiver, will do well to heed the facts which are here presented.

While the style is popular, and the author has borne in mind that his most important message is to the business man unfamiliar with radio technicalities, his presentation of the basic physical facts of radio broadcasting is clear and lucid. The limitations, as well as the advantages of broadcast advertising and publicity, are frankly discussed; and no executive controlling an advertising appropriation, local or national, could read the book without profit.

The author deals with his subject impartially: "Since commercial broadcasting is still in a formative stage, these questions cannot be answered with the definite finality to which the advertising profession is accustomed." Yet whatever had been definitely learned, when the author wrote, has been set forth here. It is to be hoped that either a later edition, or a companion work, may set forth the later developments in a business which, as are all things connected with radio, is still in a stage of rapid evolution. (R. D. W.)

THE FUNDAMENTALS OF RADIO, by R. R. Ramsey, Ph.D. Published by Ramsey Publishing Co., Bloomington, Indiana; 6" x 9", xii, 376 pages, 402 diagrams and illustrations. Price \$3.50, postpaid.

Dr. Ramsey, who is professor of physics at Indiana University and author of a previous manual, *Experimental Radio*, has prepared what is, primarily, an elementary textbook for college students, dealing with the principles of electricity, and especially of alternating current, as they are applied to radio. While the fundamental characteristics of the important circuits, from the earliest days to those of this year, are described, the details of the "hook-ups" are not explained at length. The purpose of the book is simply to give the student a thorough grounding in first principles.

"Although I have endeavored to give a non-mathematical treatment of the subject, some calculus has been introduced in a few sections," says the author; and, since a non-mathematical treatment of radio theory is almost a contradiction in terms, what he means is that practically all his formulas should be comprehensible by a student with a good high school knowledge of algebra and trigonometry. The work is, in fact, much simplified, in comparison with the average textbook on radio principles; and it is illuminated in many places by simple comparisons which make the author's statements more readily grasped. A certain dry humor lends point to many of his observations.

The book will be readily understood by many radio students who have not the preliminary training to read books which demand for their comprehension a higher degree of engineering preparation. It might have been made slightly more attractive by more careful proofreading. (C. P. M.)

Short-Wave Stations of the World

(Continued from page 453)

Kilo-Meters	Cycles	Station Name	Location	Time
92.50	3,256	W9XL	Chicago, Ill.	
91.76	3,166	WCK	Detroit, Mich. (Police Dept.)	
93.48-97.71	3,142-3,076	Aircraft		
96.93	3,121	WOOD, Deal	N. J.	
97.15	3,088	W10XZ	Airplane Television	
97.50	3,076	W9XL	Chicago, Ill.	
98.95	3,030	Metala	Sweden	11:30 a.m.-noon, 4-10 p.m.
101.7 to 105.3	2,850 to 2,950	Television		
		W3XK	Silver Springs, Md.	8 to 9 p.m. except Sunday
		WPY	Allwood, N. J.	
		W2XR	New York, N. Y.	
		W3XL	Bound Brook, N. J.	
104.4	2,870	6WF	Perth, Australia	
105.3 to 109.1	2,750 to 2,850	Television		
		W2XBA	Newark, N. J.	Tues. and Fri. 12 to 1 a.m.
		W2XCL	Brooklyn, N. Y.	
		W8XAU	Pittsburgh, Pa.	
		W1XB	Somerville, Mass.	
		W7XAO	Portland, Ore.	
		W9XAP	Chicago, Ill.	
		W2XCR	Jersey City, N. J.	8:15 and 9 h.m.
109.1 to 113.1	2,650 to 2,750	Television		
		W9XR	Chicago, Ill.	
110.2	2,722	Aircraft		
124.2	2,416	Seattle	Wash. Police and Fire Depts.	
126.1	2,398	W9XL	Chicago, Ill.	
		W2XCU	Amherst, N. J.	

Kilo-Meters	Cycles	Station Name	Location	Time
128.0-129.0	Aircraft			
129.0	2,336	W10XZ	Airplane Television	
136.4 to 142.9	2,100 to 2,200	Television		
		W8XAU	Pittsburgh, Pa.	
		W1XB	Somerville, Mass.	
		W2XCW	Schenectady, N. Y.	
		W1XAU	Boston, Mass.	
142.9 to 150 meters	2,000 to 2,100	Television		
		W2XCL	Brooklyn, N. Y.	Mon., Wed., Fri., 9 to 10 p.m.
		W9XAA	Chicago, Ill.	
		W2XBS	New York, N. Y.	frame 60 lines deep, 72 wide, 1,200 R.M.P.
		W1XAE	Springfield, Mass.	
		W8XAU	Pittsburgh, Pa.	
		W6XAM	Los Angeles	
		W2XBU	Hebron, N. Y.	
		W3XAK	Phila., Pa.	
		W3XK	Washington, D. C.	Daily except Sun., 8 to 9 p.m.
		WPY	Allwood, N. J.	
		W10XU	Airplane	
149.0-174.8	2,000-1,715	Amateur Telephony		
175.2	1,712	WKDU	Cincinnati, Ohio. (Police Dept.)	
178.1	1,684	WRDX	New York, N. Y. (Police Dept.)	
186.6	1,608	W9XAL	Chicago, Ill. (WMAA) and Aircraft Television	
187.0	1,601	W2XCU	Wireless Radio, Ampere, N. J.	
		W2XCD	DeForest Radio Co., Passaic, N. J.	
		W10XU	Airplane	
187.9	1,596	WKDT	Detroit, Mich. (Fire Dept.)	
		(Standard Television scanning, 43 lines, 900 R.P.M.)		

Radio-Craft Information Bureau

(Continued from page 464)

average grid-plate capacity of a '99 is 4.2 mmf., as against the 9.8 mmf. between grid and plate of the '01A tube.

Inter-electrode capacity plays a large part in the performance of superheterodynes, particularly the "25." A change in grid-filament or plate-filament capacity changes the tuning of the input and output circuits of any tube; and an increase in grid-plate capacity causes increased feedback, resulting in strong regeneration and perhaps oscillation.

The output of the '01A as an oscillator exceeds that of the '99 and, when it is used in this "second-harmonic super," the result is an increased output at its fundamental and harmonic frequencies, causing "heterodyne whistles" that never resolve into a station program.

(Q.) Would it be practicable to introduce a stage of tuned R.F. ahead of the input of this set, preferably in a separate unit, for the purpose of minimizing some of the numerous harmonics which render reception of many distant stations difficult or impossible? I am using a long outside antenna, inductively coupled to the loop.

(A.) There are several ways in which this excellent and convenient unit may be applied to the "Radiola 25."

The circuit shown in these columns as Fig. 49A is most easily made as an R.F. unit coupled inductively to the aerial and capacitatively to the loop, and shielded as indicated by dotted line. The lead from C3 is to be clipped to the grid side of the loop aerial. L1-L2 is a standard "antenna coupler," with its secondary tuned by C1, which must have the correct capacity for the particular make of coil used. (The "tuning curve" will not exactly follow that of the "25" unless the constants of the coil and condenser combination exactly match those of the tuning system of the receiver.) C2 is 1-mf.; C3, .0001-mf.; R, a suitable filament ballast for the tube V1; Ch, a standard R.F. choke coil. The last may be made by scramble-winding 500 turns of No. 30 to 36 insulated wire on a spool 1/2-in. in diameter, and grooved 1/2-in. wide and 1/8-in. deep; or follow the directions, given in answer to Q. 38 in the Information Bureau of the January, 1930, issue of RADIO-CRAFT Magazine.

In Fig. 49B a screen-grid tube V1 is shown arranged to amplify the loop pick-up (which may be inductively coupled to the aerial, as at present, if desired). C2, C3 and C4 are 1-mf. each. The loop, instead of being connected to the receiver, is now connected to the input of V1, the output of which is inductively coupled to the "25" through the output R.F. transformer. The secondary L2 of the last is connected to the receiver in place of the regular loop.

C1 may be an S.L.F. condenser of .00035-mf. capacity. L2 may be made by winding approximately 100 turns of No. 28 D.C.C. wire on a 2 1/4-in. tube; the exact optimum number of turns being determined by experiment. L1 consists of 50 turns of the same wire, wound over the filament end of L2. Shielding is shown in dotted lines. If a 42-volt source is used for the "A" supply of V1, only a fixed resistor of 10 ohms (R1) and another of 5 ohms (R2) will be needed. On a six-volt supply a resistor of about 12 ohms will be needed at X.

(Q.) Can a loop of the "box" type be made for the "Radiola 25?"

(A.) A satisfactory loop for this receiver may be made by winding 12 turns of wire on a frame 12 x 24 inches, spacing the turns about 1-in.

Craftsmen's Letters

(Continued from page 461)

noticeable on the short waves; because it is involved with the confusion of tongues that we have had since the days of Babel. The letters of the alphabet are pronounced differently in different languages; so that the natural difficulty of distinguishing a call from a distant station is aggravated. This was shown by the frantic endeavors of our readers to catch the call letters of XDA. However, while radio has undoubtedly increased the vogue of English throughout the world, it would be a little too much to expect stations in non-English speaking countries to make all their announcements for our benefit.—Editor.)

Radio-Craft's Opportunity Column

TO make this magazine of additional benefit to Service Men, RADIO-CRAFT has instituted a new feature, of which advantage may be taken, free of charge, by any Service Man who has enrolled himself in the NATIONAL LIST OF RADIO SERVICE MEN (by filling out in full the blank which is printed in every issue of this magazine). We will print short notices of the same nature as those which follow; and will forward to the writer of any of them the replies which may be addressed to him (by the number given) in care of RADIO-CRAFT.

We must reserve the right to condense all letters into their most essential details; and we urge all our correspondents who use this service to be as concise, though thorough, as they would be in the composition of a paid advertisement which would cost them several dollars.

Service Men seeking employment should give, at the beginning, the important details which an employer will first ask; and anyone offering employment to a Service Man should be equally specific.

It is desirable that references be given in all letters seeking employment, etc.—not for publication, but in order that RADIO-CRAFT may verify the statements made, if requested to do so, by parties interested in replying to the advertisement.

We cannot publish under this heading any advertising of a commercial nature—for the sale of goods, or instruction, etc.; or for an employment agency. We cannot publish offers of general servicing for the public, or general representation of a manufacturer in a district. For the former, local advertising mediums are available, and as to the latter, a manufacturer requesting such information will be given it directly from the files of the NATIONAL LIST OF RADIO SERVICE MEN. Announcements seeking or offering regular employment, however, will be accepted under the conditions stated above.

The writers of any of these requests may be addressed as Opportunity No. (number given below), in care of RADIO-CRAFT, 98 Park Place, New York City.

(Opportunity 11) Service Man, five years' radio experience, engineering student, seeks position with

manufacturer to obtain thorough familiarity with line, with view to position in charge of service work. Age 23. (N. J. suburb of New York.)

(Opportunity 12) Service Man wishes position with manufacturer affording advancement. Has car and testing equipment. Marietta, (Iowa.)

(Opportunity 13) Service Man, graduate School of Engineering, has Wisconsin Radio Trades certificate, seeks position offering advancement. Marietta, (Pennsylvania.)

(Opportunity 14) Service Man, three years' radio, ten years' business experience, seeks connection, research or semi-technical work. Traveling position preferred. Age 28, Married. (Chicago.)

(Opportunity 15) Service Man, N. R. I. member, who has reached the limit of small town's business, wishes position with manufacturer or dealer in larger place which will give full time. (Tennessee.)

(Opportunity 16) Service Man, graduate School of Engineering, seeks position with radio-equipped hotel, or with manufacturer. Age 22. (North Carolina.)

(Opportunity 17) Service Man, five years' radio experience, machinist, seeks to make change, preferably with manufacturer. Age 31. (Pennsylvania.)

(Opportunity 18) Service Man, radio operator, R. C. A. Institutes graduate, seeks position, California preferred, is union musician. Married. (Iowa.)

(Opportunity 19) Custom Set Builder wishes to get in touch with manufacturer of 25-cycle equipment for radio. (Ontario.)

(Opportunity 20) Service Man, experienced on receivers and power amplifiers, wishes to go to California; interested in sound projection. (Kentucky.)

(Opportunity 21) Service Man, eight years' radio experience, wishes place with manufacturer or distributor of good set, to specialize. Will go anywhere. Speaks Norwegian. Age 32. (Iowa.)

(Opportunity 22) Service Man, three years' professional experience, desires connection with manufacturer offering advancement. Salary not important. Age 21. (Ontario.)

An Expert Training in ELECTRICITY

Here, in seven fact-filled books, is a complete course in electrical practice. Step-by-step information is given on every practical subject, from simple wiring to operation of power stations and transmission systems. These well-known books are already the daily reference guide of nearly 60,000 highly paid engineers and experts. A short daily study period will do YOU for a better job and increased pay.

JUST OUT!
A new printing in a semi-flexible Keratol binding.

The New Croft Library of PRACTICAL ELECTRICITY
2785 pages, 2045 illustrations



See these books FREE!
Fill in and mail the coupon below and we will send you the entire set of seven volumes for 10 days' free examination.
NO MONEY DOWN
Small Monthly Payments

McGraw-Hill
Free Examination Coupon
McGraw-Hill Book Company, Inc.,
370 Seventh Avenue, New York.
Send me, for 10 days' free examination, the New Croft Library of Practical Electricity, seven volumes in the semi-flexible Keratol binding. If satisfactory I will send you \$1.50 in ten days and \$2.00 monthly until the special price of \$19.50 has been paid. If not wanted I will return the books.
Name
Home Address
City and State
Position
Name of Company RC-3-30

TRI-STATE HEADQUARTERS
Pennsylvania—Ohio—West Va.
WHOLESALE RADIO
To DEALERS and SET BUILDERS we offer the most prompt and efficient service. We handle only the best merchandise and give MAXIMUM DISCOUNTS.
★ GET OUR CATALOG ★
CAMERADIO
430 WOOD ST.
at Diamond St.
PITTSBURGH PA.

PATENTS Write for Free Guide Book, "HOW TO OBTAIN A PATENT" and Record of Invention Blank. Send model or sketch and description of your invention for our Inspection and Advice Free. RADIO and ELECTRICAL Cases a Specialty.
EASY PAYMENTS IN INSTALLMENTS
VICTOR J. EVANS & CO., 923-9th, Washington, D. C.

PATENTS TRADE-MARKS
DON'T LOSE YOUR RIGHTS TO PATENT PROTECTION
Before disclosing your invention to anyone send for blank form "EVIDENCE OF CONCEPTION" to be signed and witnessed.
LANCASTER, ALLWINE & ROMMEL
(Registered Patent Attorneys)
475 Ouzay Bldg., Washington, D. C.
Originators of famous "Evidence of Conception"

DIRECT FOREIGN RECEPTION!

Without dependence on local re-broadcasting

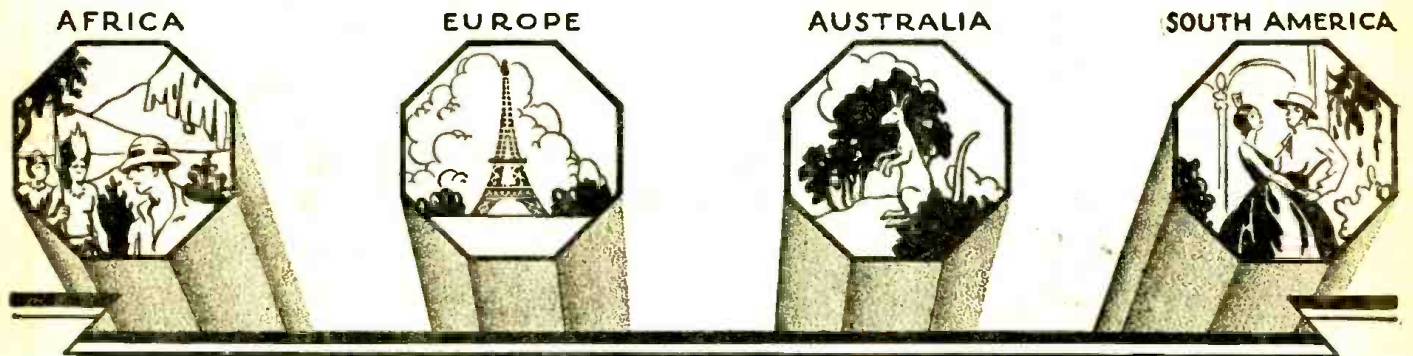

PILOT SUPER-WASP

Short-Wave and Broadcast Receiver, 14 to 500 Meters
In Kit Form for A.C. or Battery Operation

WIDEN YOUR CIRCLE OF ENTERTAINMENT

Your broadcast receiver is silent below 200 meters, but the Super-Wasp, swooping down to 14 meters and up to 500, unlocks a *new world of trans-oceanic radio* you never heard before! And you get it directly from the foreign station and not from a local rebroadcast. You'll be amazed by the wealth and variety of radio entertainment now being broadcast via short waves from civilized countries all over the world! . . . Enthusiasts report European, African, South American and Australian stations—music delightfully new and strange to listeners "fed-up" with domestic radio programs! To assure consistently satisfactory operation, Pilot engineers developed the Pilotron P-227, which naturally makes it a splendid tube for broadcast receivers.

CUSTOM SET BUILDERS' PRICE

KIT K-115

The A. C. Super-Wasp. Use your own ABC pack or Pilot K-111 at \$16.50, specially designed for the Super-Wasp. Power Pack and Tubes Extra.

\$34⁵⁰



KIT K-110

The battery-operated Super-Wasp. Batteries and Tubes Extra.

\$29⁵⁰



PILOT RADIO & TUBE CORP.

WORLD'S LARGEST RADIO PARTS PLANT . . EST. 1908
 Chicago Office, 234 South Wells Street



**323 BERRY STREET
 BROOKLYN • NEW YORK**
 San Francisco Office, 1278 Mission Street

A

JOINING THE RADIO INTERNATIONAL GUILD

costs only 50c for a full year's membership, which includes lapel pin, certificate, and the Guild's Official Organ—"Radio Design," published quarterly and replete with the latest and greatest radio construction articles, also new developments in short-wave, television and aviation radio. Enclose 50c coin or stamps with this coupon and return to Radio International Guild, 103 Broadway, Brooklyn, N. Y.



Name

Address

City State

WHAT EVERY ELECTRICIAN WANTS TO KNOW!

JUST OUT!—Latest Exact Information from A to Z!

We take pleasure in announcing: **"AUDELS NEW ELECTRIC LIBRARY"**

New and More Uses for Electricity offer great opportunities to men who can handle this power correctly. Modern electrification of industry calls for trained men who know how to handle electricity accurately.

Simple as A. B. C.—"Audels New Electric Library" gives latest, exact information from foundations of electrical practice to latest modern applications. This is a NEW practical and theoretical course in electricity for home study and ready reference.

Here are the answers to your questions, giving you the real dope that every electrician must know. They chart your knowledge, taking away the uncertainty of guess work.

NEW!

As Easy As ABC



Latest information, fully illustrated, covering:—

Fundamental Principles and Rules of Electricity, Magnetism, Armature Winding, Repairs, Dynamos, D.C. Motors, Construction, Installation, Maintenance and Trouble Shooting, Tests and Testing Instruments, Storage Battery, Construction and Repairs, Alternating Current Principles and Diagrams, Power Factor, Alternators, Transformers, A.C. Motors, Windings, Reconnecting, Converters, Switches & Fuses, Circuit Breakers, Relays, Condensers, Regulators, Rectifiers, Meters, Switchboards, Power Station Practice, House Light & Power Wiring, Circuits, High Tension, Transmission, Plans, Calculations, Code, Electric Railways, Signals, Elevators, Hoists & Cranes, Gas Engines, Auto & Aero Ignition, Starters, Radio, Telephone, Telegraph, Bells & Signals, Motion Pictures, Talkies, Lighting, Illumination, Electric Refrigeration, Heating, X-Ray, Plating, Welding, Pumps, Compressors, Domestic & Farm Appliances, An Electric Calculator for Engineers and Mechanics, Practical Mathematics for Ready Reference, A New Electric Dictionary & Encyclopedia of Words.

7 Books Now on Sale 5 in Preparation

The Library contains 12 books—the first 7 books containing 3600 pages with thousands of diagrams and illustrations are now ready; the remaining 5 books are in preparation. A pocket-size, flexibly bound series that is valuable wherever electricity is used.

Beautiful, timely books for service—pocket size; completely illustrated with diagrams and charts; simplified, easy to read and understand. No electrical man can afford to pass up this opportunity. Extremely low price; buy on your own terms.

Beautiful, Timely Books



Read for Profit

BUY ON YOUR OWN TERMS

- PLAN 1—ONE BOOK A MONTH**
Please enter my subscription to "Audels New Electric Library" to consist of twelve volumes, price \$1.50 a volume (\$10.50 for the seven volumes now ready). Mail one volume each month and as they are received, I will mail you \$1.50 promptly.
- PLAN 2—PAY 50¢ OR MORE A WEEK**
Please ship me for one week's free trial the first seven volumes of "Audels New Electric Library," \$1.50 each (\$10.50 for the seven volumes now ready). The remaining five volumes to be mailed as issued at \$1.50 a volume. If satisfied, I will mail you 60¢ or more each week as payment for the first seven books and I will pay for the last five numbers as I receive them at \$1.50 each.
- PLAN 3—CASH PRICE \$9.98**
Please ship me prepaid "Audels New Electric Library" for which I enclose remittance \$9.98 in full payment for the seven volumes now ready. You are to ship me on one week's trial the remaining five volumes as they are issued for which I will either pay \$1.50 each as received or return to you. This price is based on 5% cash discount.

THEO. AUDEL & CO.,
65 West 23rd St., New York, N. Y.

Please ship me the NEW "Audels Electric Library" on the plan marked (X).

NAME

ADDRESS

OCCUPATION

EMPLOYED BY

Ger

QUESTIONS AND ANSWERS
AUDELS NEW ELECTRIC LIBRARY ILLUSTRATED

NEW!

SATISFACTION GUARANTEED!
"Audels New Electric Library" is backed by our 50-year record as helping hand publishers. Satisfaction always guaranteed.



BRAND NEW

CORONA *GENUINE Model #3*

Lowest Price—Easiest Terms Ever Offered

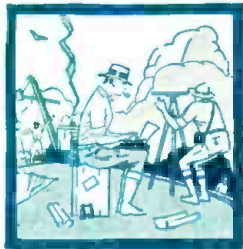

HERE'S your chance to own that *brand new* Genuine Model 3 Corona you've wanted — on the easiest terms ever offered — at **LOWEST PRICE** ever offered. Complete in every detail; back spacer, etc. *Manufacturer's Guarantee.* Recognized the world over as the finest, strongest, sturdiest portable built.

Yours for **10 DAYS FREE**

Only a limited number of these splendid machines available. To get one, you must act now! Experience the joy this personal writing portable typewriter can give you! Use it ten days free! See how easy it is to run and the splendidly typed letters it turns out. Ideal for the office desk, home, traveling. Small, compact, light, convenient. Don't send out letters, manuscripts, reports, bills in poor handwriting when you can have

this Corona at such a low price on such easy terms. Remember these are *brand new* machines right out of the Corona factory.

Carrying Case FREE
If You Act Now!

Leatheroid carrying case, oiler, instructions free on this offer. Send no money—just the coupon. Without delay or red tape we will send you the Corona. Try it 10 days. If you decide to keep it, send us only \$2—then \$3 a month until our special price of \$39.90 is paid. Now is the time to buy. This offer may never be repeated.

Save Money—Use This Coupon

Smith Typewriter Sales Corp., (Corona Division)
469 E. Ohio St., Chicago, Ill. Dept. 1133

Ship me the Corona, F. O. B. Chicago. On arrival I'll deposit \$2 with express agent. If I keep the machine, I'll send you \$3 a month until the \$37.90 balance of \$39.90 price is paid; the title to remain with you until then. I am to have 10 days to try the typewriter. If I decide not to keep it, I will repack and return to express agent, who will return my \$2. You are to give your standard guarantee.

Name _____
Address _____
Employed by _____